

## Personal Audio System

### Système audio personnel

### Sistema de audio personal

Quick Start Guide

Guide de prise en main

Guía de inicio rápido



\* 4 5 3 9 7 4 1 1 1 \* (1)

SRS-X3

©2014 Sony Corporation Printed in China

## English

### Manuals supplied



#### Quick Start Guide (this document)

Provides you with instructions on how to connect the unit with BLUETOOTH devices and basic operations.



#### Reference Guide

Provides you with precautions and product specifications.



#### Help Guide

Read the Help Guide on your computer or smartphone, when you want to know how to use the unit in greater detail. The Help Guide also contains a troubleshooting guide which provides you with remedies for the problems you might encounter.

URL:

<http://rd1.sony.net/help/speaker/srs-x3/uc/>

Two-dimensional code:



### Charging the Unit

This unit has a built-in lithium-ion rechargeable battery. Charge the battery before using the unit for the first time.

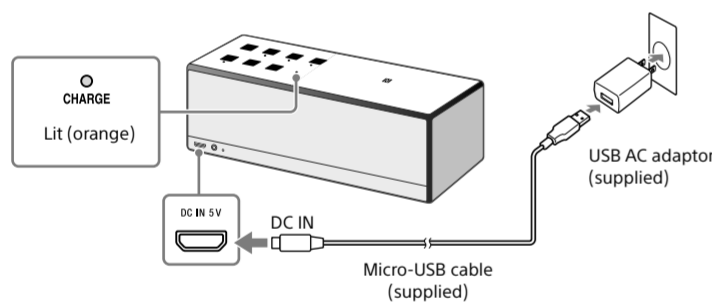

Charging starts when the unit is connected to an AC outlet via the USB AC adaptor, and the CHARGE indicator lights up orange. Charging is completed in about five hours and the indicator goes off. Charge the unit while it is turned off.

### How to Make Wireless Connection with BLUETOOTH Devices

Select your case from the 3 pairing types, below. BLUETOOTH devices need to be "paired" with each other beforehand.

#### Pairing and connecting with a BLUETOOTH device

The unit can be paired with up to eight BLUETOOTH devices. When pairing with two or more BLUETOOTH devices, perform the following pairing procedure for each device.

- 1 Press the I/⏻ (power) button to turn on this unit. The I/⏻ (power) indicator lights up green.

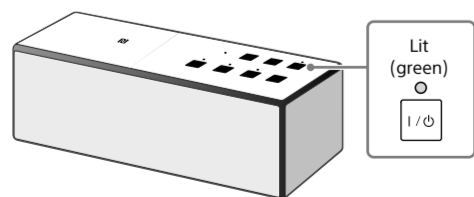

- 2 Press the Ⓜ (BLUETOOTH) – PAIRING button. The Ⓜ (BLUETOOTH) indicator begins to flash white.

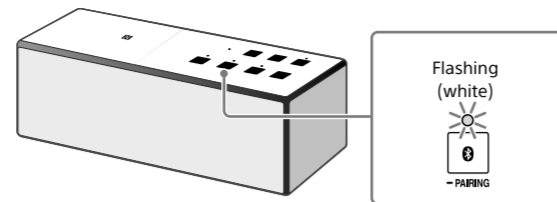

When you use the BLUETOOTH function for the first time, and when you only press the Ⓜ (BLUETOOTH) – PAIRING button, the Ⓜ (BLUETOOTH) indicator will begin to flash white quickly and the unit enters pairing mode automatically.

- 3 Press and hold the Ⓜ (BLUETOOTH) – PAIRING button until beeps are heard and the Ⓜ (BLUETOOTH) indicator begins to flash white quickly. The unit enters pairing mode.

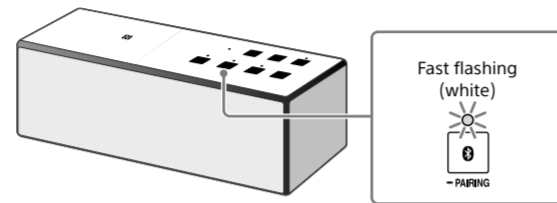

- 4 Perform the pairing procedure on the BLUETOOTH device to detect this unit.

When a list of detected devices appears on the display of the BLUETOOTH device, select "SONY:SRS-X3."

If passkey input is required on the display of a BLUETOOTH device, input "0000."

- 5 Make the BLUETOOTH connection from the BLUETOOTH device. When the BLUETOOTH connection is established, the Ⓜ (BLUETOOTH) indicator on the unit stays lit.

#### Connecting with a paired BLUETOOTH device

- 1 Turn on this unit.
- 2 Press the Ⓜ (BLUETOOTH) – PAIRING button. The Ⓜ (BLUETOOTH) indicator begins to flash white.
- 3 Make the BLUETOOTH connection from the BLUETOOTH device. When the BLUETOOTH connection is established, the Ⓜ (BLUETOOTH) indicator on the unit stays lit.

#### Connecting with a smartphone by One-touch (NFC)

By touching the unit with a smartphone, the unit proceeds to pairing and BLUETOOTH connection, then turns on automatically after connection is established.

#### Note

- If your smartphone is the type that goes into standby mode in response to a magnetic force, it may be unable to be connected by NFC.

#### Compatible smartphones

NFC-compatible smartphones with Android 2.3.3 or later installed

#### NFC

NFC (Near Field Communication) is a technology enabling short-range wireless communication between various devices, such as smartphones and IC tags. Thanks to the NFC function, data communication - for example, BLUETOOTH pairing - can be achieved easily by simply touching NFC compatible devices together (i.e., at the N-Mark symbol or location designated on each device).

- 1 Set the NFC function of the smartphone to on. For details, refer to the operating instructions supplied with the smartphone.
  - If your smartphone OS is Android 2.3.3 or later, and less than Android 4.1: proceed to step 2.
  - If your smartphone OS is Android 4.1 or later: proceed to step 4.

- 2 Download and install the app "NFC Easy Connect." "NFC Easy Connect" is a free Android app you can download from Google Play. Download the app by searching for "NFC Easy Connect" or access it by using the following two-dimensional code. Fees may be charged for downloading the app.

To download by the two-dimensional code, use a two-dimensional code reader app.



#### Note

- The app may not be available in some countries and/or regions.

- 3 Start "NFC Easy Connect" on the smartphone. Make sure that the app screen is displayed.

- 4 Touch this unit with the smartphone.

Unlock the screen of the smartphone beforehand. Keep touching the smartphone on the N marked part of the unit until the smartphone responds.

When the unit is off, if the smartphone touches it and BLUETOOTH connection is established, then the unit will turn on.

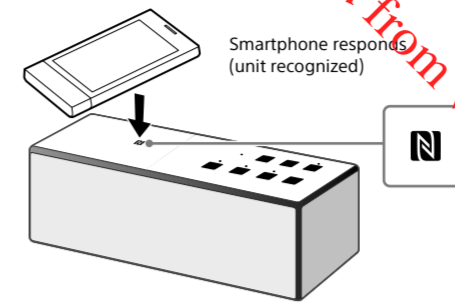

Follow the on-screen instructions to establish the connection. When the BLUETOOTH connection is established, the Ⓜ (BLUETOOTH) indicator on the unit stays lit. To disconnect, touch the unit with the smartphone again.

#### Hint

If you cannot connect the unit, try the following.

- Start the app on the smartphone, and move the smartphone slowly over the N marked part of the unit.
- If the smartphone is in a case, remove it from the case.
- Make sure that the app screen is displayed on the smartphone.

### Listening and Calling

Operate the unit after making BLUETOOTH connection with your BLUETOOTH device.

#### Listening to music

Profile: AZDP, AVRCP

Start playback on the BLUETOOTH device, and adjust the volume.

Set the volume at an appropriate level on the connected device, and adjust the volume with the VOL -/+ buttons on the unit.

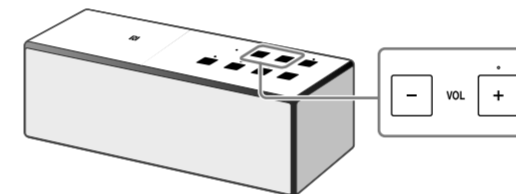

#### Making a call/Receiving a call

Profile: HSP, HFP

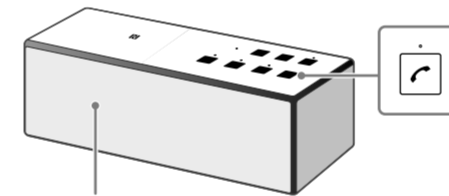

Operate your smartphone to make a call.

To terminate a call, press the Ⓜ button on the unit.

Press the Ⓜ button on the unit when an incoming call arrives.

Operate in the same way when an incoming call arrives while you are listening to music.

- The BLUETOOTH® word mark and logos are owned by the Bluetooth SIG, Inc. and any use of such marks by Sony Corporation is under license.
- The N Mark is a trademark or registered trademark of NFC Forum, Inc. in the United States and in other countries.
- Android™ and Google Play™ are trademarks of Google Inc.
- Other trademarks and trade names are those of their respective owners.

## Français

### Manuels fournis



#### Guide de prise en main (ce document)

Vous fournit les instructions pour connecter l'appareil avec des périphériques BLUETOOTH ainsi que les opérations de base.



#### Guide de référence

Vous fournit les précautions et les spécifications du produit.



#### Manuel d'aide

Lisez le Manuel d'aide sur votre ordinateur ou votre téléphone intelligent lorsque vous voulez avoir plus de détails sur l'utilisation de l'appareil. Le Manuel d'aide contient également un guide de dépannage qui vous fournit des solutions aux problèmes que vous pourriez rencontrer.

URL :

<http://rd1.sony.net/help/speaker/srs-x3/uc/>

Code en deux dimensions :



### Chargement de l'appareil

L'appareil est équipé d'une pile rechargeable intégrée au lithium-ion. Chargez la pile avant d'utiliser l'appareil pour la première fois.

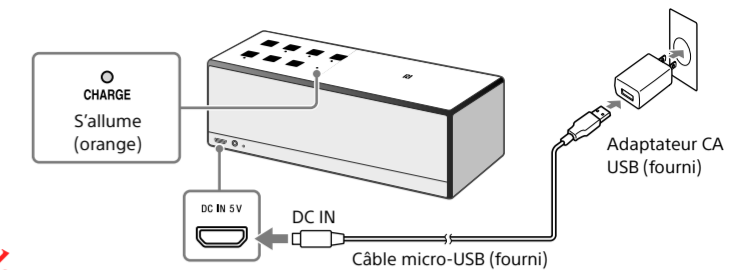

Le chargement démarre lorsque l'appareil est branché à une prise de courant via l'adaptateur CA USB, et le témoin CHARGE (orange) s'allume. Le chargement dure environ cinq heures, puis le témoin s'éteint. Chargez l'appareil pendant qu'il est éteint.

### Comment établir une connexion sans fil avec des périphériques BLUETOOTH

Sélectionnez votre cas parmi les 3 types de pairage ci-dessous. Il est nécessaire au préalable de procéder au « pairage » des périphériques BLUETOOTH.

#### Pairage et connexion avec un périphérique BLUETOOTH

Cet appareil peut être païré avec un maximum de huit périphériques BLUETOOTH. Voici la procédure de pairage pour chacun des périphériques lors du pairage de deux périphériques BLUETOOTH ou plus.

- 1 Appuyez sur la touche I/⏻ (alimentation) pour mettre l'appareil sous tension. Le témoin I/⏻ (alimentation) s'allume en vert.

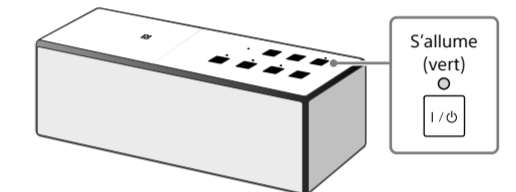

- 2 Appuyez sur la touche Ⓜ (BLUETOOTH) – PAIRING. Le témoin Ⓜ (BLUETOOTH) se met à clignoter en blanc.

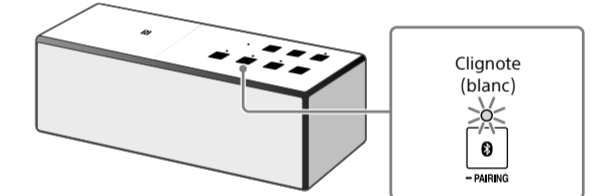

Lorsque vous utilisez la fonction BLUETOOTH pour la première fois et que vous appuyez simplement sur la touche Ⓜ (BLUETOOTH) – PAIRING, le témoin Ⓜ (BLUETOOTH) commencera à clignoter rapidement en blanc et l'appareil passera automatiquement en mode de pairage.

- 3 Appuyez sur la touche Ⓜ (BLUETOOTH) – PAIRING et maintenez-la enfoncée jusqu'à ce que vous entendiez des bips sonores et que le témoin Ⓜ (BLUETOOTH) commence à clignoter rapidement en blanc. Le mode de pairage de l'appareil est activé.

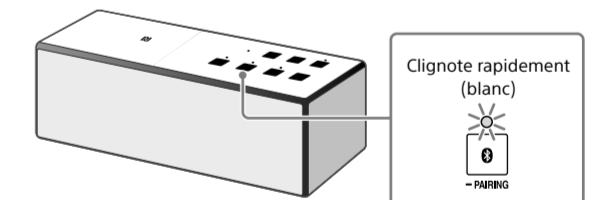

- 4 Effectuez la procédure de pairage sur le périphérique BLUETOOTH pour détecter l'appareil.

Lorsque la liste de périphériques détectés apparaît sur l'écran du périphérique BLUETOOTH, sélectionnez « SONY:SRS-X3 ». Si un code est demandé sur l'écran d'un périphérique BLUETOOTH, saisissez « 0000 ».

- 5 Vérifiez la connexion BLUETOOTH sur le périphérique BLUETOOTH. Lorsque l'appareil est connecté au périphérique BLUETOOTH, le témoin Ⓜ (BLUETOOTH) s'allume.

#### Connexion avec un périphérique BLUETOOTH païré

- 1 Allumez l'appareil.
- 2 Appuyez sur la touche Ⓜ (BLUETOOTH) – PAIRING. Le témoin Ⓜ (BLUETOOTH) se met à clignoter en blanc.
- 3 Effectuez la connexion BLUETOOTH sur le périphérique BLUETOOTH. Lorsque l'appareil est connecté au périphérique BLUETOOTH, le témoin Ⓜ (BLUETOOTH) s'allume.

