



©2016 Sony Corporation Printed in China <http://www.sony.net/>

CFD-S70

WARNING

To reduce the risk of fire or electric shock, do not expose this apparatus to rain or moisture.

To reduce the risk of fire, do not cover the ventilation opening of the appliance with newspapers, tablecloths, curtains, etc. Do not expose the appliance to naked flame sources (for example, lighted candles).

To reduce the risk of fire or electric shock, do not expose this apparatus to dripping or splashing, and do not place objects filled with liquids, such as vases, on the apparatus.

As the main plug is used to disconnect the unit from the mains, connect the unit to an easily accessible AC outlet. Should you notice an abnormality in the unit, disconnect the main plug from the AC outlet immediately.

The unit is not disconnected from the AC power source (mains) as long as it is connected to the wall outlet, even if the unit itself has been turned off.

Do not install the appliance in a confined space, such as a bookcase or built-in cabinet.

Excessive sound pressure from earphones and headphones can cause hearing loss.

Do not expose the batteries (battery pack or batteries installed) to excessive heat such as sunshine, fire or the like for a long time.

The nameplate is located on the bottom exterior.

CAUTION



RISK OF ELECTRIC SHOCK. DO NOT OPEN.

Notice for customers: the following information is only applicable to equipment sold in countries applying EU directives

This product has been manufactured by or on behalf of Sony Corporation, 1-7-1 Konan Minato-ku Tokyo, 108-0075 Japan. Inquiries relate to product compliance based on European Union legislation shall be addressed to the authorized representative, Sony Belgium, bijkantor van Sony Europe Limited, Da Vincilaan 7-D1, 1935 Zaventem, Belgium. For any service or guarantee matters, please refer to the addresses provided in the separate service or guarantee documents.

For customers in Europe and Oceania

Disposal of waste batteries and electrical and electronic equipment (applicable in the European Union and other European countries with separate collection systems)

This symbol on the product, the battery or on the packaging indicates that the product and the battery shall not be treated as household waste. On certain batteries this symbol might be used in combination with a chemical symbol.

The chemical symbols for mercury (Hg) or lead (Pb) are added if the battery contains more than 0.0005% mercury or 0.004% lead. By ensuring these products and batteries are disposed of correctly, you will help prevent potentially negative consequences for the environment and human health which could otherwise be caused by inappropriate waste handling. The recycling of the materials will help to conserve natural resources.

In case of products that for safety, performance or data integrity reasons require a permanent connection with an incorporated battery, this battery should be replaced by qualified service staff only. To ensure that the battery and the electrical and electronic equipment will be treated properly, hand over these products at end-of-life to the applicable collection point for the recycling of electrical and electronic equipment. For all other batteries, please view the section on how to remove the battery from the product safely. Hand the battery over to the applicable collection point for the recycling of waste batteries. For more detailed information about recycling of this product or battery, please contact your local Civic Office, your household waste disposal service or the shop where you purchased the product or battery.

This product is designed to be used for the following purposes:

- Playing back music sources on discs or tapes
- Listening to radio stations
- Recording on a tape
- Listening to sound from a connected optional component

Basic Operations

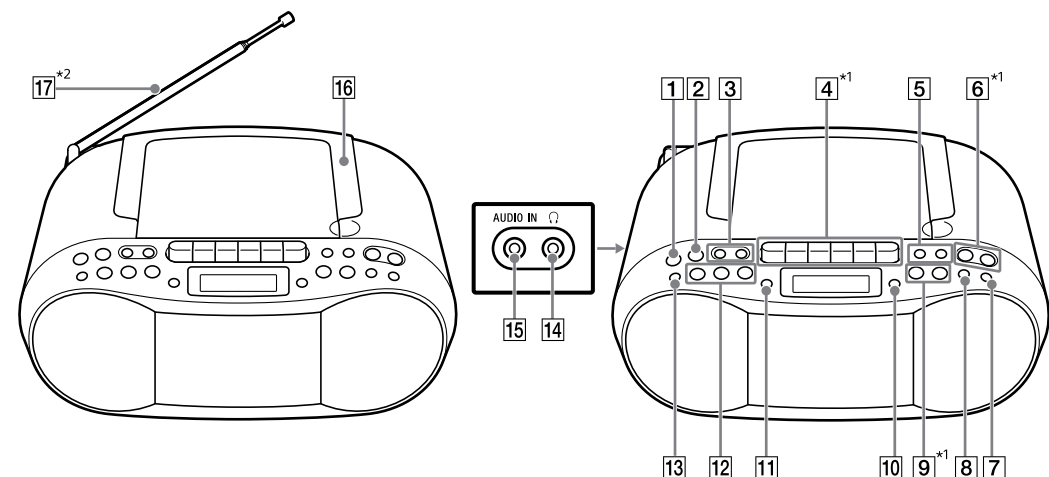

*1 CD PLAY/PAUSE (▶II) [9], VOLUME + [6] and ◀ [4] have a tactile dot.
*2 Extend the FM antenna [17] only when listening to FM radio (for AM radio, a ferrite bar antenna is built into the unit).

Before using the unit

To turn the power on or off
Press ⏻ (power) [1].

To adjust the volume
Press VOLUME + or - [6]. The volume level of this unit is adjustable in steps from 0 to 31. If you want to adjust the volume level continuously, hold the button down, and release it at the desired level.

To listen through headphones
Connect headphones to the ◡ (headphones) jack [14]. To protect your hearing, avoid listening at excessive volume level when listening through headphones.

To turn the bass enhancement function on or off
Press MEGA BASS [7]. When you press the button, the function will either switch on ("MEGA BASS" lights up) or off ("MEGA BASS" disappears). By default, this function is turned on.

Playing a music disc

1 Press ⏻ [1] to turn on the power of the unit.
2 Insert the tip of your finger into the opening tab to open the CD compartment cover.

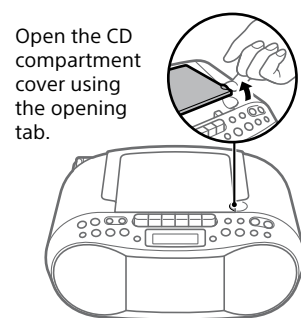

Audio CD
(Total number of tracks and total playing time appear in order).

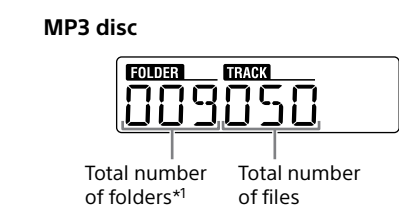
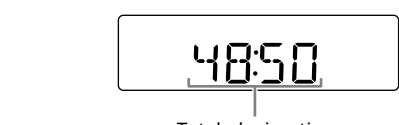
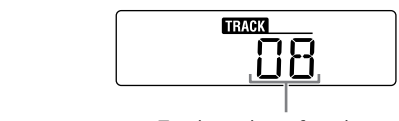

4 Press CD PLAY/PAUSE (▶II) [9] to start playback.

Playing time*2,3

*1 If MP3 files are present only in the root directory, "001" appears on the display.
*2 If the playing time is longer than 100 minutes, "-----" appears on the display.
*3 By pressing DISPLAY/ENTER [11], the playback screen changes between showing playing time and the current track number (or showing the current folder and file numbers (MP3)).

To switch to the CD function from other functions
Press CD PLAY/PAUSE (▶II) [9]. If a previously played disc has been set, playback will start automatically. Press STOP [■] [9] to stop playback if necessary.

To	Do this
Pause playback	Press CD PLAY/PAUSE (▶II) [9]. To return to playback, press the button again.
Stop playback	Press STOP [■] [9]. If you press CD PLAY/PAUSE (▶II) [9] after playback has been stopped, playback will start from the beginning of the track/file you were last playing (Resume Play). If you want to start playback from the first track/file on the disc, press STOP [■] [9] twice, and then press CD PLAY/PAUSE (▶II) [9].
Select a folder on an MP3 disc	Press TUNE/□ + or - [3].
Select a track/file	Press ◀◀ or ▶▶ [5]. You can skip tracks/files one by one.
Find a point in a track/file	Hold down ◀◀ or ▶▶ [5] during playback, and release the button at the desired point. When locating a point while paused, press CD PLAY/PAUSE (▶II) [9] to start playback after the desired point is found.

Note
Resume Play is cancelled in the following cases:
– When you open the CD compartment cover.
– When you turn off the power.

Example of folder structure and playing order
The playing order of the folders and files is as follows. However, the playing order may differ from the original order on the disc, depending on the recording method used.

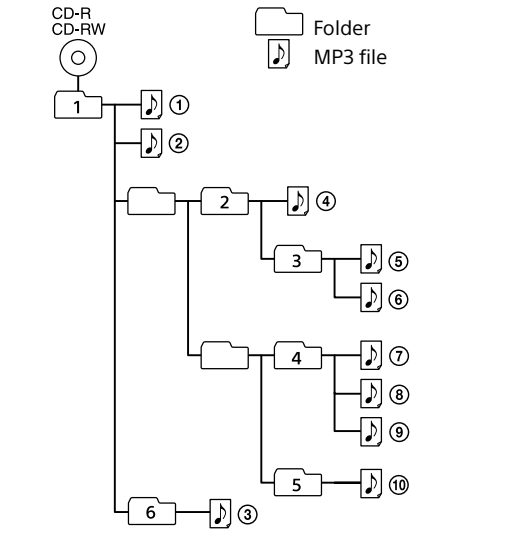

Notes on MP3 discs

- When a disc is loaded, the unit reads all the files on that disc. During this time, "READ" is flashing. If there are many folders or non-MP3 files on the disc, it may take a long time for play to begin or for the next MP3 file to start to play.
- We recommend that non-MP3 files or unnecessary folders are excluded when creating MP3 discs.
- During playback, audio files other than MP3 files are skipped even if those files are included in a folder.
- This system can only play MP3 files that have a file extension of ".mp3". Note that even if the file name has the correct file extension but the actual file was created in a different audio format, this unit may produce noise or may malfunction.
- MP3 PRO format is not supported.
- This unit cannot play audio files on a disc in the following cases:
 - When the total number of audio files exceeds 413.
 - When the total number of folders on a single disc exceeds 99 (including the "ROOT" folder).
 - When the directory level (folder depths) exceeds 9 (including the "ROOT" folder).

Listening to the radio

1 Press ⏻ [1] to turn on the power of the unit.
2 Adjust the antenna for optimum reception.

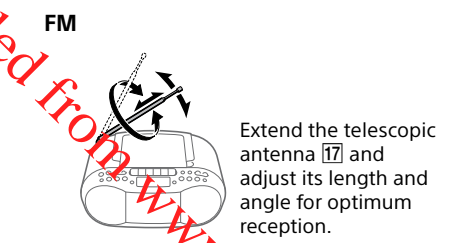

FM
Orient the unit itself for optimum reception (a ferrite bar antenna is built into the unit).

AM
3 Press FM/AM [2] repeatedly to select the "FM" or "AM" band.
4 Hold down TUNE/□ + or - [3] until the frequency digits begin to change on the display. The unit automatically scans the radio frequencies and stops when it finds a clear station. If you cannot tune to a station using automatic tuning mode, press TUNE/□ + or - [3] repeatedly to change the frequency step by step. When an FM stereo broadcast is received, "ST" lights up on the display.

Tips

- The unit of frequency of tuned stations is MHz for the FM band and kHz for the AM band.
- If the stereo FM reception is noisy, press PLAY MODE [10] repeatedly until "Mono" appears on the display. You will lose the stereo effect, but the reception will be improved.

To improve radio reception
Use the radio in a place where radio signals can be easily received such as near a window. Also, adjust the antenna (FM) or reorient the unit itself (AM) for good reception.

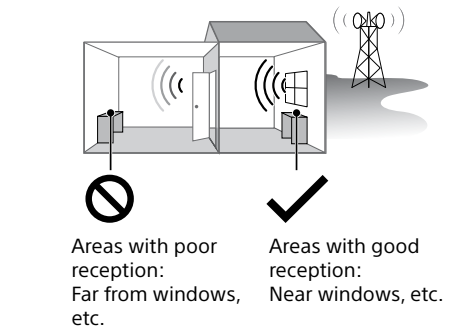

If the reception problem still persists, try changing the installation location. Avoid places such as the following:

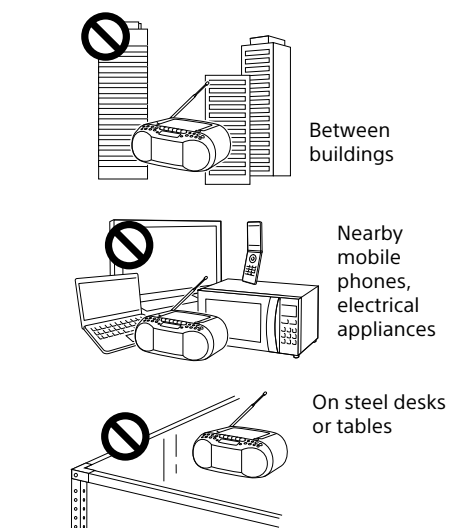

Presetting radio stations

You can store radio stations in the unit's memory. You can preset up to 30 radio stations, 20 for FM and 10 for AM.

1 Press ⏻ [1] to turn on the power of the unit.
2 Press FM/AM [2] repeatedly to select the "FM" or "AM" band.
3 Hold down FM/AM [2] until "AUTO" flashes on the display.

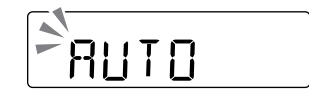

4 Press DISPLAY/ENTER [11] to store the station. The stations are stored in memory from lower frequencies to higher ones.

If a station cannot be preset automatically
You need to preset a station with a weak signal manually.
1 Press FM/AM [2] repeatedly to select a band.
2 Tune to the desired station.
3 Hold down DISPLAY/ENTER [11] until "FM-xx" or "AM-xx" flashes on the display. (Example: FM)



4 Press PRESET + or - [5] until the preset number for the station you want flashes on the display.
5 Press DISPLAY/ENTER [11] to store the station. If another station is already assigned to the selected preset number, that station is replaced by the new one. If you want to cancel presetting the station, press STOP [■] [9].

Tip
The preset radio stations remain in the unit's memory even in the following situations.
– The AC power cord is unplugged.
– The batteries are removed.

Listening to preset radio stations

1 Press ⏻ [1] to turn on the power of the unit.
2 Press FM/AM [2] repeatedly to select the "FM" or "AM" band.
3 Press PRESET + or - [5] to select a stored preset number for the desired radio station.

Tip
By repeatedly pressing DISPLAY/ENTER [11] while listening to the radio, the radio information changes between showing the preset number and the frequency. The preset number display automatically returns to the frequency display after 2 seconds have elapsed.

Presetting stations to FAVORITE RADIO STATIONS buttons

You can preset up to three favorite stations to the three FAVORITE RADIO STATIONS (-SET) [12] buttons. Assign one FM or AM program for each button.

1 Press FM/AM [2] repeatedly to select the band "FM" or "AM."
2 Tune to the station you want to preset.
3 Press and hold the desired FAVORITE RADIO STATIONS (-SET) [12] until you hear a beep. The tuned station is preset to the selected button of FAVORITE RADIO STATIONS (-SET) [12] and the same number as that of the button will light up on the display.

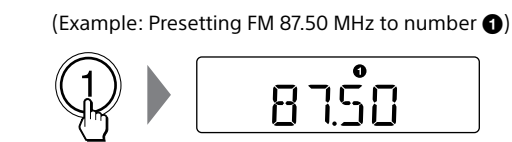

To change the preset station
Repeat steps 1 to 3. The preset station on the button will be replaced by the new one.

Listening to preset stations with FAVORITE RADIO STATIONS buttons

Press the desired FAVORITE RADIO STATIONS (-SET) [12] button.

Note
To prevent the preset from being changed by mistake, do not hold down the button. If doing so, the preset on the button will be replaced by the currently tuned station.

Playing a tape

Check the following items before starting operation.
• Use Type I (normal) tapes only. Type II (high position), Type III (ferro-chrome) and Type IV (metal) tapes are not supported.
• If there is tape slack, rewind the slack using a pencil to avoid damaging the tape or the unit.

1 Press ▶▲ [4] (▶), insert a cassette tape into the cassette tape compartment (▶) and then close the compartment cover.

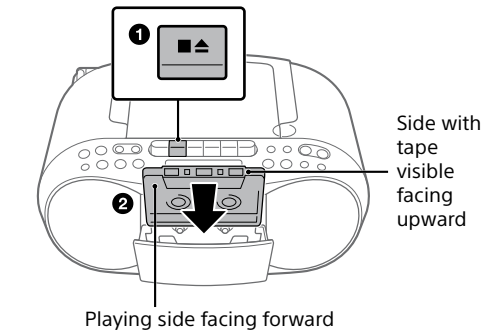

2 Press ◀ [4] to start playback.
Other operations

To	Do this
Stop playback	Press ▶▲ [4].
Pause playback	Press II [4]. To resume playback, press the button again.
Fast-forward or rewind	Press ◀◀ or ▶▶ [4].
Eject the cassette	Press ▶▲ [4].

Notes

- Do not turn off the power during the tape playback. Doing so may cause malfunction. Make sure to stop playback before turning off the power.
- If the tape is wound to the beginning or end and ◀◀ or ▶▶ [4] is not released, "STOP TAPE" will flash on the display. Make sure to press ▶▲ [4] to release the button. "STOP TAPE" starts flashing 8 minutes after a fast-forward (◀◀ [4]) or rewind (▶▶ [4]) operation. After about 10 minutes have elapsed, the unit turns off automatically.
- When "STOP TAPE" flashes, always check the ◀◀ or ▶▶ [4] button and make sure to release the button.
- When the time set on the Sleep Timer has elapsed during playback, the "SLEEP" indicator will start flashing but the unit will not turn off. The unit will turn off after the end of playback.

Recording on a tape

Check the following items before starting operation.
• Use Type I (normal) tapes only. Type II (high position), Type III (ferro-chrome) and Type IV (metal) tapes are not supported.
• Make sure that the overwrite protection tab has not been removed. If the tab has been removed, cover the broken tab using adhesive tape.
• Be sure to connect the AC power cord to avoid an unexpected recording failure.

1 Press ⏻ [1] to turn on the power of the unit, and then prepare the source you want to record.
■ To record CD-DA tracks or MP3 files on a disc
Place a disc in the CD compartment. Make sure not to start playback. See "Playing a music disc."
■ To record a radio program
Tune to the desired station. See "Listening to the radio."
■ To record sound from a connected optional component
Press AUDIO IN [8] and connect an optional component such as a TV, portable digital music player, etc. to the AUDIO IN jack [16], and then start playback.
2 Press ▶▲ [4] (▶), insert a cassette tape into the cassette tape compartment (▶) and then close the compartment cover.

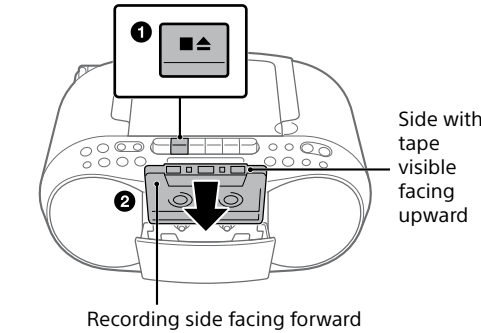

3 Press **■** [4] to start recording (the play button **▶** [4] will depress automatically at the same time).

■ When recording from a disc

Playback starts automatically and recording of all the tracks/files on the disc proceeds from the first track/file. When the tape reaches the end, recording stops automatically.

■ When recording a radio program or sound from a connected optional component

Recording continues until the tape reaches the end.

Note
When the time set on the Sleep Timer has elapsed during recording, the "SLEEP" indicator will start flashing but the unit will not turn off. The unit will turn off after the end of recording.

Tips

- Adjusting the volume or the audio emphasis will not affect the recording level.
- If the AM program makes whistling sound after you have press **■** [4] in step 3, press **PLAY MODE** [10] repeatedly to select the position of ISS (Interference Suppress Switch) that may decrease the noise.

Other operations

To	Do this
Stop recording	Press ▶ [4].
Pause recording	Press ■ [4]. To resume recording, press the button again.

To record starting from a specific track/file

Press **◀** or **▶** [5] to select the track/file on the disc, then press **■** [4]. Playback starts automatically, and recording of the selected track/file and the following tracks/files proceeds until the tape reaches the end.

To record from partway through the current CD-DA track or MP3 file

Press **CD PLAY/PAUSE** [▶|II] [9] to pause playback where you want to start recording, then press **■** [4].

To record favorite CD-DA tracks or MP3 files on a disc

Create a program (see "Creating your own program (Program Play)"), then press **■** [4] to start recording.

To erase recorded cassette tapes

To erase a cassette tape, you need to record silence over the previous recording.

1 Press **⏻** [1] to turn on the power of the unit.

2 Insert a recorded tape into the cassette tape compartment.

3 Press **■** [4]. Erasing process starts, and previous recording is overwritten with silent data.

Other Operations

Selecting the CD play mode

You can select the CD play mode while a disc is stopped. Check the following items before selecting the CD play mode. If you try to set or change the play mode during playback, "PUSH STOP" will appear.

- When a disc is playing, be sure to stop playback by pressing **STOP** [■] [9].
- If you have switched to the CD function from another function by pressing **CD PLAY/PAUSE** [▶|II] [9], press **STOP** [■] [9] once to stop playback.

Press **PLAY MODE** [10] repeatedly.



Each time you press the button, the indication changes as follows:

- Normal play (None)
- Single repeat (◁ 1)
- All repeat (↶)
- Selected folder play (◻)*
- Selected folder repeat play (↶, ◻)*
- Shuffle play (♫)
- Program play (PGM)
- Program repeat play (↶, PGM)

* These functions are available only when playing MP3 files on an MP3 disc.

Note
The selected CD play mode is cleared in the following situations.

- The AC power cord is unplugged.
- The batteries are removed.
- When you open the CD compartment cover.
- When you turn off the power of the unit.

Playing tracks/files repeatedly (Repeat Play)

You can set the unit to repeatedly play CD-DA tracks on an audio CD, MP3 files on a CD-R/CD-RW disc, in normal and program play modes.

1 Press **⏻** [1] to turn on the power of the unit, and place a disc in the CD compartment.

2 Proceed as follows.

To repeat	Do this
A single track/file	<ol style="list-style-type: none">Press PLAY MODE [10] repeatedly until "↶ 1" appears.Press ◀ or ▶ [5] to select a track/file that you want to repeat. When you want to specify a folder that contains MP3 files, press TUNE/◻ + or - [3] first to select a folder, and then press ◀ or ▶ [5] to select a file.Press CD PLAY/PAUSE [▶ II] [9].
All tracks/files	<ol style="list-style-type: none">Press PLAY MODE [10] repeatedly until "↶" appears.Press CD PLAY/PAUSE [▶ II] [9].

A selected folder on an MP3 disc

- Press **PLAY MODE** [10] repeatedly until "◻" and "↶" appear.
- Select a folder by pressing **TUNE**/**◻** + or - [3].
- Press **CD PLAY/PAUSE** [▶|II] [9].

Programmed tracks/files

- Program tracks/files (see "Creating your own program (Program Play)").
- Press **PLAY MODE** [10] until "PGM" and "↶" appear on the display.
- Press **CD PLAY/PAUSE** [▶|II] [9].

To cancel Repeat Play

Press **STOP** [■] [9] to stop playback, and then press **PLAY MODE** [10] repeatedly until "↶" (or "↶ 1") disappears from the display.

Playing tracks/files in random order (Shuffle Play)

You can set the unit to play CD-DA tracks on an audio CD, MP3 files on a CD-R/CD-RW disc in random order.

- Press **⏻** [1] to turn on the power of the unit, and place a disc in the CD compartment.
- Press **PLAY MODE** [10] repeatedly until "♫" appears on the display.
- Press **CD PLAY/PAUSE** [▶|II] [9] to start Shuffle Play.

To cancel Shuffle Play

Press **STOP** [■] [9] to stop playback, and then press **PLAY MODE** [10] repeatedly until "♫" disappears from the display.

Tip
During Shuffle Play, you cannot select the previous track/file by pressing **◀** [5].

Creating your own program (Program Play)

You can arrange the playing order of up to 25 tracks/files on a disc.

- Press **⏻** [1] to turn on the power of the unit, and place a disc in the CD compartment.
- Press **PLAY MODE** [10] repeatedly until "PGM" appears on the display.
- Press **◀** or **▶** [5] to select a track/file. When you want to specify a folder that contains MP3 files, press **TUNE**/**◻** + or - [3] first to select a folder, and then press **◀** or **▶** [5] to select a file.

4 Press **DISPLAY/ENTER** [11].

The track/file is programmed and the program step number appears.

(Example: audio CD)

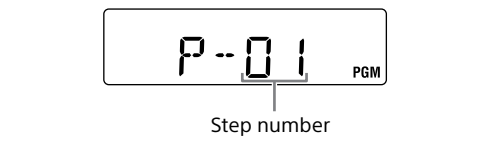

5 Repeat steps 3 and 4 to program additional tracks/files.

6 Press **CD PLAY/PAUSE** [▶|II] [9] to start Program Play.

To play the same program again, press **CD PLAY/PAUSE** [▶|II] [9].

Note that the created program is cleared in the following cases:

- When you open the CD compartment cover.
- When you turn off the power of the unit in the CD function.

Note

If you try to program 26 tracks/files or more, "FULL" flashes on the display.

To display programmed track/file information

After creating your own program, you can check information about programmed tracks/files.

Press **STOP** [■] [9] to stop playback, and then press **DISPLAY/ENTER** [11] repeatedly. The display changes as follows:

Total number of steps ↔ Last programmed track/file number

To cancel Program Play

Press **STOP** [■] [9] to stop playback, and then press **PLAY MODE** [10] repeatedly until "PGM" disappears from the display.

To delete all tracks/files in the current program

Stop playback, and then press **STOP** [■] [9]. "noSTEP" appears and you can create a new program, following the procedure "Creating your own program (Program Play)."

Using the Sleep Timer

You can set the unit to turn off automatically after a set time has elapsed.

1 Press **SLEEP** [13].

The default setting ("90") appears and the "SLEEP" indicator lights up on the display.

2 Press **SLEEP** [13] repeatedly to select the desired setting.

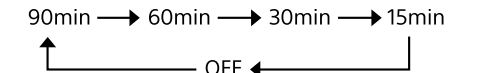

Each time you press the button, the duration (in minutes) changes on the display, and the selected setting is confirmed automatically after about 4 seconds.

To cancel the Sleep Timer

Press **SLEEP** [13] repeatedly to select "OFF" or turn off the unit.

Tips

- The "SLEEP" indicator will flash once every 8 seconds while the Sleep Timer is activated.
- The "SLEEP" indicator will start flashing on the display about 1 minute before the unit turns off.
- You can check the time left until the unit turns off by pressing **SLEEP** [13] again after setting the Sleep Timer. However, be sure not to perform this operation while the "SLEEP" indicator is flashing (flashing starts 1 minute before the unit turns off). If you perform this operation during this time, the Sleep Timer will be canceled instead of displaying the time remaining.
- When the set time has elapsed during a tape function operation (playing/recording/erasing), the "SLEEP" indicator will start flashing but the unit will not turn off. The unit will turn off after the operation ends.

- Be sure to release the **◀** or **▶** [4] button by pressing **▶** [4] after the unit is turned off when a fast-forward or rewind operation is performed in the tape function.
- Be sure to turn off the power of the optional component connected to the AUDIO IN jack [8] when using the Sleep Timer in the audio in function. The Sleep Timer does not turn off the component power.

Connecting optional components

You can enjoy the sound from an optional component, such as a TV, portable digital music player, through the speakers of this unit. Be sure to turn off the power of each component before making any connections.

For details, refer to the instruction manual of the component to be connected.

- Connect the AUDIO IN jack [8] to the line output jack of the portable digital music player, TV or other component using an audio connection cable (not supplied).
- Turn the connected component on.
- Press **AUDIO IN** [8] and start playing sound on the connected component.

The sound from the connected component is output from the speakers.

To connect the unit to a TV or video recorder/player, use an extension cable (not supplied) with a stereo-mini jack on one end and two phono plugs on the other end.

Checking the remaining battery power

When using the unit on battery power, you can check how much battery power remains.

Battery levels and remaining battery power

The remaining battery power is displayed in 5 levels as shown below (battery icons are for illustrative purposes only). The higher the number, the more battery power remains.

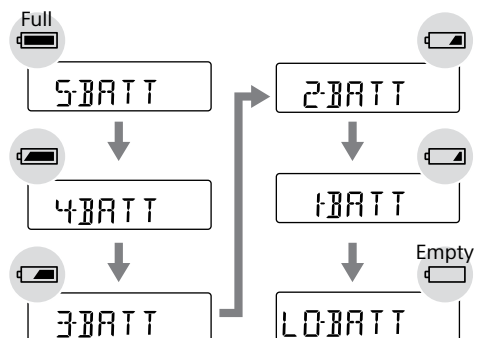

After the "LO-BATT" alert flashes for 8 seconds, the unit will turn off automatically.

To check the battery level, perform the following.

■ **When using the CD or FM/AM function**
Press **DISPLAY/ENTER** [11] repeatedly.

■ **When using the tape or audio in function**
Press **DISPLAY/ENTER** [11] once.

About the battery alert message

When the battery power drops to a certain level, the message "LO-BATT" will flash for 8 seconds and then the unit power will go off automatically. Replace all the batteries with new ones when this message appears.

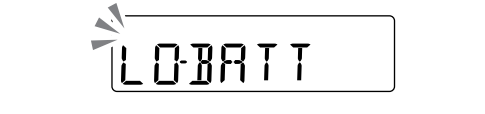

Note

If you turn the unit on again without replacing the batteries after "LO-BATT" appears, you may be able to use some function such as the tuner for a short period of time, but the following issues may occur. Replace the batteries with new ones when "LO-BATT" appears.

- The unit turns on but then turns off after "LO-BATT" flashes for 8 seconds.
- The unit will not turn on.

Cleaning the tape heads and tape path

Failure to clean the tape heads can cause degraded sound quality or inability of the unit to play or record tapes. Clean the capstan, pinch roller, play/recording head, and erase-head after every 10 hours of use using a commercially available cleaning kit. Clean their surfaces as shown below using a cotton swab moistened with cleaning fluid included in the kit.

■ **To clean the pinch roller, capstan and play/recording head**
Press **◀** [4] (1) and then perform cleaning (2).

■ **To clean the erase-head**
Press **■** [4] (3) while holding down the lever (4) with your finger, and then perform cleaning (2).

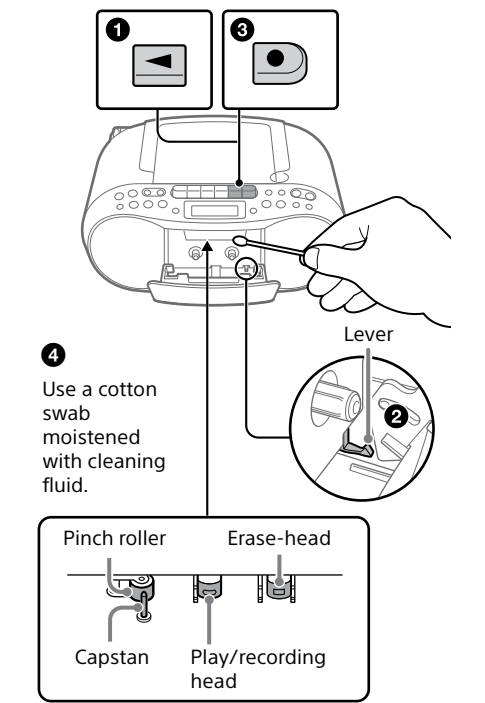

Precautions

Discs that this unit CAN play

- Audio CD (CD-DA)*1 tracks)
- CD-R/CD-RW discs on which CD-DA tracks are recorded in CD-DA format.
- CD-R/CD-RW that contains MP3 files and is finalized**2 correctly.

*1 CD-DA is the abbreviation for Compact Disc Digital Audio. It is a recording standard used for audio CDs.

**2 Finalizing is the process to make the CD-R/CD-RW discs playable on the consumer disc player products, and the finalizing can be enabled or disabled as optional settings during disc creation in most recording software.

Discs that this unit CANNOT play

- CD-R/CD-RW other than those recorded in audio CD format or formats conforming to ISO 9660 Level 1/Level 2 or Joliet
- CD-R/CD-RW of poor recording quality, CD-R/CD-RW with scratches or that is dirty, or CD-R/CD-RW recorded using an incompatible recording device
- CD-R/CD-RW that is unfinalized or finalized incorrectly
- BD-ROM, BD-R/BD-RE
- DVD-ROM, DVD-R/DVD-RW, DVD+R/DVD+RW, DVD-RAM

Notes on discs

- Clean the CD with a cleaning cloth if the disc is dirty. Wipe the disc from the center out. If there are scratches, dirt or fingerprints on the disc, a tracking error may occur.
- Do not use solvents such as benzine, thinner, commercially available cleaners or anti-static spray intended for vinyl LPs.
- Do not expose the CD to direct sunlight or heat sources such as hot air ducts, or leave it in a car parked in direct sunlight as there can be a considerable rise in temperature inside the car.
- Do not stick paper or a sticker on the CD, or scratch the surface of the CD.
- After playing, store the CD in its case.

Note on DualDiscs

A DualDisc is a two sided disc product which mates DVD recorded material on one side with digital audio material on the other side. However, since the audio material side does not conform to the Compact Disc (CD) standard, playback on this product is not guaranteed.

Music discs encoded with copyright protection technologies

This product is designed to playback discs that conform to the Compact Disc (CD) standard. Recently, various music discs encoded with copyright protection technologies are marketed by some record companies. Please be aware that among those discs, there are some that do not conform to the CD standard and may not be playable by this product.

Notes on cassettes

- Remove the overwrite protection tab from side A or B to prevent accidental recording. If you want to reuse the tape for recording, cover the broken tab using adhesive tape.

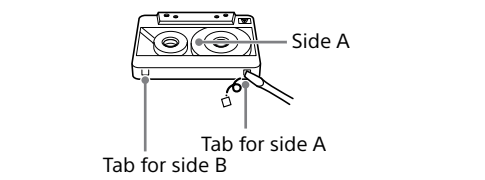

- The use of a cassette tape with more than 90 minutes of play time is not recommended except for long, continuous recording or playback.

On safety

- As the laser beam used in the CD player section is harmful to eyes, do not attempt to disassemble the casing. Refer servicing to qualified personnel only.
- Should any solid object or liquid fall into the unit, unplug the unit, and have it checked by qualified personnel before operating it any further.
- Discs with non-standard shapes (e.g., heart, square, star) cannot be played on this unit. Attempting to do so may damage the unit. Do not use such discs.

On power sources

- For AC operation, use the supplied AC power cord; do not use any other cord.
- Unplug the unit from the wall outlet if it is not to be used for an extended period of time.
- When not using the batteries, remove them to avoid damage that can be caused by battery leakage or corrosion.

On placement

- Do not leave the unit in a location near heat sources, in a place subject to direct sunlight, excessive dust or mechanical shock, or in a car subject to the direct rays of the sun.
- Do not place the unit near the appliances that generate heat, such as lighting fixtures or heaters. The heat from those appliances may deform the enclosure and cause the system to malfunction.
- Do not place the unit on an inclined or unstable surface.
- Do not place anything within 10 mm of the rear of the cabinet. The ventilation openings must be unobstructed for the unit to operate properly and prolong the life of its components.

- Since a strong magnet is used for the speakers, keep personal credit cards using magnetic coding or spring-wound watches away from the unit to prevent possible damage from the magnet.

On operation

- If the unit is brought directly from a cold to a warm location, or is placed in a very damp room, moisture may condense on the lens inside the CD player section. Should this occur, the unit will not operate properly. In this case, remove the CD and wait about an hour for the moisture to evaporate.

On handling the unit

- Do not leave the CD compartment open to avoid dust and debris accumulation.
- When carrying the unit, hold it by the handle [16] to prevent it from dropping.

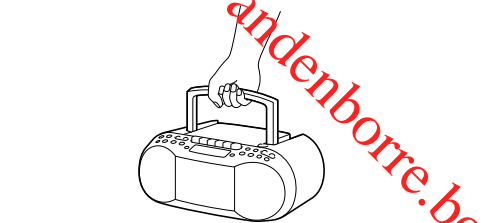

On cleaning the cabinet

- Clean the cabinet, panel and controls using a soft cloth slightly moistened with a mild detergent solution. Do not use any type of abrasive pad, scouring powder, or solvent, such as alcohol or benzine.

If you have any questions or problems concerning your unit, consult your nearest Sony dealer.

Troubleshooting

General

“LO-BATT” flashing message appears on the display.

- Replace all the batteries with new ones. This message appears when using the unit on batteries and the battery power drops to a certain level.

The power does not turn on.

- Make sure the AC power cord is connected to the wall outlet securely.
- Make sure the connector of AC power cord is inserted into the AC IN jack securely.
- Check if the batteries are inserted correctly, matching the polarities.

There is no sound.

- Make sure the appropriate function is selected for the music or sound source you want to listen to.
- Unplug the headphones when listening through speakers.

The sound is noisy.

- Is someone using a mobile phone or other equipment emitting radio waves near the unit? If so, move the unit away from such devices.

A small humming noise is heard from the radio.

- This is not a malfunction. You may hear a small humming noise from the radio depending on the status of the power supply.

CD player

The CD player does not play even when a CD is in place.

- Place the CD with the label side up.
- Clean the CD.
- Take out the CD and leave the CD compartment open for about an hour to dry moisture condensation.
- The CD-R/CD-RW is blank or unfinalized.
- There are no playable MP3 files on the disc.
- There is a problem with the quality of the CD-R/CD-RW, recording device or application software.

“noCD” appears when the disc is loaded.

- No disc is set in the CD compartment. Set a disc.
- The CD may have a reading problem. Replace the disc.
- The CD may be placed upside down. Place the disc with the label side up.
- An unplayable disc (DVD, BD, etc.) is loaded. Replace the disc.

“00” appears on the display when the disc is loaded.

- No audio files recorded in supported formats, or a file to be played back has an unsupported file extension.

“Err” appears when the disc is loaded.

- The CD may be dirty. Clean the disc.
- The CD may have scratches. Replace the disc.
- The CD may have a reading problem. Replace the disc.
- A blank disc may be set in the CD compartment.

The sound drops out.

- Reduce the volume.
- Clean the CD, or replace it if the CD is badly damaged.
- Place the unit in a location free from vibrations.
- Clean the lens with a commercially available blower.

- The sound may drop out or noise may be heard when using a poor quality CD-R/CD-RW or if there is a problem with the recording device or application software.

Starting playback takes more time than usual.

- The following discs take a longer time to start playback.
 - A disc recorded with a complicated tree structure.
 - A disc that has many folders, files or non-MP3 files.

Radio

The sound is weak or reception is poor.

- Replace all the batteries with new ones.
- Move the unit away from nearby TVs.
- For FM reception, extend the antenna to its full length, and reorient it for best FM reception. For AM reception, reorient the unit itself to find the best reception.
- If you are in a building, listen near a window.
- If a mobile phone is placed close to the unit, a loud noise may be heard from the unit. Keep the phone away from the unit.

The TV picture is unstable.

- If you are listening to an FM program near a TV with an indoor antenna, move the unit away from the TV.

Tape

The tape does not move when you press an operation button.

- Close the cassette compartment cover securely.

Noise is heard during playback.

- This is not a malfunction. You may hear background noise ("hissing noise"), mechanical noise, or noise due to electromagnetic interference in the playback.

The [4] button does not function or the tape does not start playback or recording.

- Make sure that the overwrite protection tab has not been removed.

Poor or distorted playback, recording or erasing quality.

- Clean the capstan, pinch roller, play/recording head and erase-head. See "Cleaning the tape heads and tape path" for details.
- Demagnetize the heads using a commercially available tape head demagnetizer.
- Use Type I (normal) tapes only. Type II (high position), Type III (ferro-chrome) and Type IV (metal) tapes are not supported.

After trying the suggested remedies, if the problem persists, unplug the AC power cord or remove all the batteries. After all the indications on the display disappear, plug in the AC power cord again, or re-insert the batteries. If the problem persists, consult your nearest Sony dealer.

Specifications

CD player section	System
	Compact disc digital audio system
	Laser diode properties
	Emission duration: Continuous
	Laser output: Less than 44.6 μW
	(This output is the value measurement at a distance of 200 mm from the objective lens surface on the optical pick-up block with 7 mm aperture.)
	Number of channels
	2
	Frequency response
	20 Hz — 20,000 Hz +/-2 dB
	Wow and flutter
	Below measurable limit
	Supported audio format
	MP3 (MPEG 1 Audio Layer-3)
	Radio section
	Frequency range
	FM: 87.5 MHz — 108 MHz (50 kHz step)
	AM: 531 kHz — 1,602 kHz (9 kHz step)
	Intermediate frequency
	FM: 128 kHz