

SAMSUNG

FULL MANUAL

HW-Q70T

Imagine the possibilities

Thank you for purchasing this Samsung product.

To receive more complete service, please register
your product at www.samsung.com/register

SAFETY INFORMATION









SAFETY WARNINGS

TO REDUCE THE RISK OF ELECTRIC SHOCK, DO NOT REMOVE THE COVER (OR BACK).

NO USER-SERVICEABLE PARTS ARE INSIDE.

REFER SERVICING TO QUALIFIED SERVICE PERSONNEL.

Refer to the table below for an explanation of symbols which may be on your Samsung product.

	<p style="text-align: center;">CAUTION RISK OF ELECTRIC SHOCK. DO NOT OPEN.</p>	
	<p>This symbol indicates that high voltage is present inside. It is dangerous to make any kind of contact with any internal part of this product.</p>	
	<p>This symbol indicates that this product has included important literature concerning operation and maintenance.</p>	
	<p>Class II product : This symbol indicates that it does not require a safety connection to electrical earth (ground). If this symbol is not present on a product with a power cord, the product MUST have a reliable connection to protective earth (ground).</p>	
	<p>AC voltage : This symbol indicates that the rated voltage marked with the symbol is AC voltage.</p>	
	<p>DC voltage : This symbol indicates that the rated voltage marked with the symbol is DC voltage.</p>	
	<p>Caution, Consult instructions for use : This symbol instructs the user to consult the user manual for further safety related information.</p>	

WARNING

- To reduce the risk of fire or electric shock, do not expose this appliance to rain or moisture.

CAUTION

- TO PREVENT ELECTRIC SHOCK, MATCH WIDE BLADE OF PLUG TO WIDE SLOT, FULLY INSERT.
- This apparatus shall always be connected to a AC outlet with a protective grounding connection.
- To disconnect the apparatus from the mains, the plug must be pulled out from the mains socket, therefore the mains plug shall be readily operable.
- Do not expose this apparatus to dripping or splashing. Do not put objects filled with liquids, such as vases on the apparatus.
- To turn this apparatus off completely, you must pull the power plug out of the wall socket. Consequently, the power plug must be easily and readily accessible at all times.

Wiring the Main Power Supply Plug (UK Only)

IMPORTANT NOTICE

The mains lead on this equipment is supplied with a moulded plug incorporating a fuse. The value of the fuse is indicated on the pin face of the plug and if it requires replacing, a fuse approved to BS1362 of the same rating must be used. Never use the plug with the fuse cover removed. If the cover is detachable and a replacement is required, it must be of the same colour as the fuse fitted in the plug. Replacement covers are available from your dealer. If the fitted plug is not suitable for the power points in your house or the cable is not long enough to reach a power point, you should obtain a suitable safety approved extension lead or consult your dealer for assistance.

However, if there is no alternative to cutting off the plug, remove the fuse and then safely dispose of the plug. Do not connect the plug to a mains socket as there is a risk of shock hazard from the bared flexible cord. Never attempt to insert bare wires directly into a mains socket. A plug and fuse must be used at all times.

IMPORTANT

The wires in the mains lead are coloured in accordance with the following code:– BLUE = NEUTRAL BROWN = LIVE As these colours may not correspond to the coloured markings identifying the terminals in your plug, proceed as follows:– The wire coloured BLUE must be connected to the terminal marked with the letter N or coloured BLUE or BLACK. The wire coloured BROWN must be connected to the terminal marked with the letter L or coloured BROWN or RED.

WARNING : DO NOT CONNECT EITHER WIRE TO THE EARTH TERMINAL WHICH IS MARKED WITH THE LETTER E OR BY THE EARTH SYMBOL , OR COLOURED GREEN OR GREEN AND YELLOW.

PRECAUTIONS

1. Ensure that the AC power supply in your house complies with the power requirements listed on the identification sticker located on the bottom of your product. Install your product horizontally, on a suitable base (furniture), with enough space around it for ventilation (7~10 cm). Make sure the ventilation slots are not covered. Do not place the unit on amplifiers or other equipment which may become hot. This unit is designed for continuous use. To fully turn off the unit, disconnect the AC plug from the wall outlet. Unplug the unit if you intend to leave it unused for a long period of time.
2. During thunderstorms, disconnect the AC plug from the wall outlet. Voltage peaks due to lightning could damage the unit.
3. Do not expose the unit to direct sunlight or other heat sources. This could lead to overheating and cause the unit to malfunction.
4. Protect the product from moisture (i.e. vases), and excess heat (e.g. a fireplace) or equipment creating strong magnetic or electric fields. Unplug the power cable from the AC wall socket if the unit malfunctions. Your product is not intended for industrial use. It is for personal use only. Condensation may occur if your product has been stored in cold temperatures. If transporting the unit during the winter, wait approximately 2 hours until the unit has reached room temperature before using.
5. The battery used with this product contains chemicals that are harmful to the environment. Do not dispose of the battery in the general household trash. Do not expose the battery to excess heat, direct sunlight, or fire. Do not short circuit, disassemble, or overheat the battery. Danger of explosion if the battery is replaced incorrectly. Replace only with the same or equivalent type.

CONTENTS

01	Checking the Components	6
02	Product Overview	7
	Front Panel / Top Panel of the Soundbar	7
	Bottom Panel of the Soundbar	8
03	Using the Soundbar Remote Control	9
	Inserting Batteries before using the Remote Control (AA batteries X 2)	9
	How to Use the Remote Control	9
	Using the Hidden Buttons (Buttons with more than one function)	12
	Output specifications for the different sound effect modes	12
	Adjusting the Soundbar volume with a TV remote control	13
04	Connecting the Soundbar	14
	Connecting the power and units	14
	– Manually connecting the Subwoofer	15
	– LED Indicator Lights on the Rear of Subwoofer	17
	Connecting an SWA-9000S (Sold Separately) to your Soundbar	18
05	Using a wired connection to the TV	20
	Method 1. Connecting with HDMI	20
	– Connecting the TV that supports HDMI ARC (Audio Return Channel)	20
	Method 2. Connecting using an Optical Cable	21
06	Using a wireless connection to the TV	23
	Connecting via Bluetooth	23
07	Connecting an External Device	25
	Method 1. Connecting using an HDMI Cable (Capable of Dolby Atmos decoding and playback)	25
	Method 2. Connecting using an Optical Cable	26

08	Connecting a Mobile Device	27
	Method 1. Connecting via Bluetooth	27
	Method 2. Connecting via Wi-Fi (Wireless Network)	30
09	Connecting an Amazon product	31
	Connect and use with an Amazon product (Amazon Echo)	31
	Use voice commands to control the Soundbar	31
	Using the Tap Sound	32
10	Installing the Wall Mount	33
	Installation Precautions	33
	Wallmount Components	33
11	Installing the Soundbar above a TV Stand	35
	Component	35
12	Software Update	36
	Auto Update	36
	USB Update	36
	Initialisation	37
13	Troubleshooting	38
14	Licence	40
15	Open Source Licence Notice	40
16	Important Notes About Service	40
17	Specifications and Guide	41
	Specifications	41

01 CHECKING THE COMPONENTS

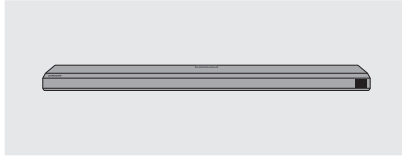

Soundbar Main Unit



**Soundbar Remote Control /
Batteries**



Subwoofer

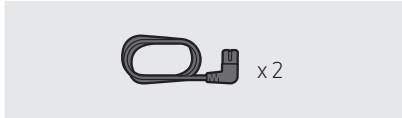

**Power Cord
(Subwoofer, Soundbar)**

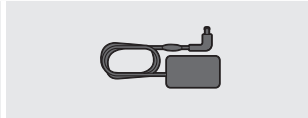

**AC/DC Adapter
(Main Unit)**

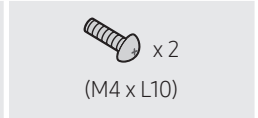

Screw



Wall Mount Guide



Holder-Screw



Bracket-Wall Mount

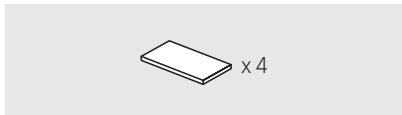

Rubber-Foot

- For more information about the power supply and power consumption, refer to the label attached to the product. (Label: Bottom of the Soundbar Main Unit)
- To purchase additional components or optional cables, contact a Samsung Service Centre or Samsung Customer Care.
- For more information about the wallmount or rubber-foot, see pages 33~35.
- Design, specifications, and App screen are subject to change without prior notice.
- The appearance of the accessories may differ slightly from the illustrations above.

02 PRODUCT OVERVIEW

Front Panel / Top Panel of the Soundbar

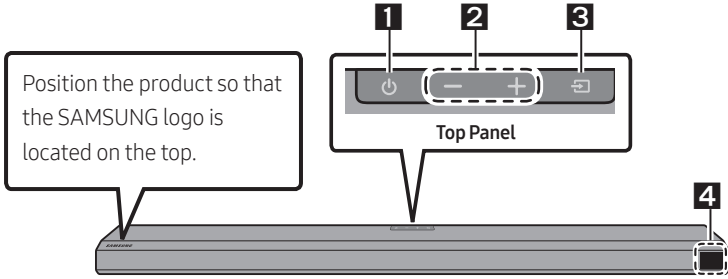

1	<p> (Power) Button Turns the power on and off.</p>												
2	<p> (Volume) Button Adjusts the volume.</p>												
3	<p> (Source) Button Selects the source input mode.</p> <table border="1"> <thead> <tr> <th>Input mode</th> <th>Display</th> </tr> </thead> <tbody> <tr> <td>Optical Digital input</td> <td>D.IN</td> </tr> <tr> <td>ARC (HDMI OUT) input</td> <td>D.IN → TV ARC (Auto conversion)</td> </tr> <tr> <td>HDMI input</td> <td>HDMI</td> </tr> <tr> <td>Wi-Fi mode</td> <td>WIFI</td> </tr> <tr> <td>BLUETOOTH mode</td> <td>BT</td> </tr> </tbody> </table>	Input mode	Display	Optical Digital input	D.IN	ARC (HDMI OUT) input	D.IN → TV ARC (Auto conversion)	HDMI input	HDMI	Wi-Fi mode	WIFI	BLUETOOTH mode	BT
Input mode	Display												
Optical Digital input	D.IN												
ARC (HDMI OUT) input	D.IN → TV ARC (Auto conversion)												
HDMI input	HDMI												
Wi-Fi mode	WIFI												
BLUETOOTH mode	BT												
4	<p>Display Displays the product's status and current mode. D.IN → HDMI → Wi-Fi → BT</p>												

- When you plug in the AC cord, the power button will begin working in 4 to 6 seconds.
- When you turn on this unit, there will be a 4 to 5 second delay before it produces sound.
- If you hear sounds from both the TV and Soundbar, go to the **Settings** menu for the TV audio and change the TV speaker to **External Speaker**.

Bottom Panel of the Soundbar

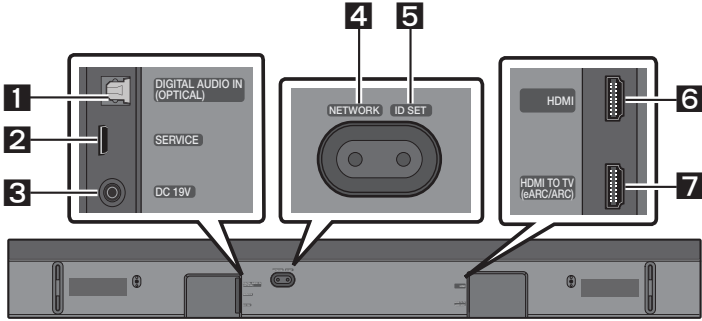

1	DIGITAL AUDIO IN (OPTICAL) Connect to the digital (optical) output of an external device. (See page 26)
2	SERVICE Connect a USB storage device to upgrade the product's software.
3	DC 19V (Power Supply In) Connect the AC/DC power adapter. (See page 14)
4	NETWORK Press to connect to a wireless network (Wi-Fi) via the SmartThings app.
5	ID SET Press to connect the Soundbar to surround speakers and a subwoofer wirelessly. (The surround speaker is sold separately.)
6	HDMI Inputs digital video and audio signals simultaneously using an HDMI cable. Connect to the HDMI output of an external device. (See page 25)
7	HDMI TO TV (eARC/ARC) Connect to the HDMI jack on a TV. (See page 20)

- When disconnecting the power cable of the AC/DC power adaptor from a wall outlet, pull the plug. Do not pull the cable.
- Do not connect this unit or other components to an AC outlet until all connections between components are complete.

03 USING THE SOUNDBAR REMOTE CONTROL



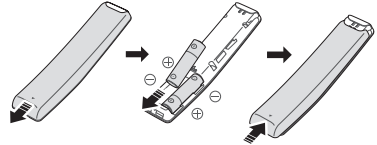

Inserting Batteries before using the Remote Control (AA batteries X 2)



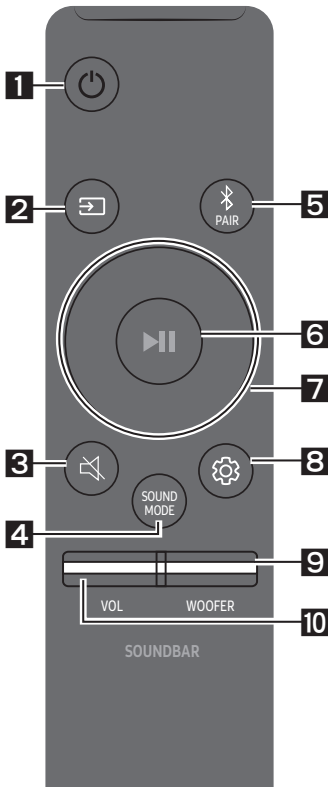

Slide the back cover in the direction of the arrow until it is completely removed. Insert 2 AA batteries (1.5V) oriented so that their polarity is correct. Slide the back cover back into position.







How to Use the Remote Control

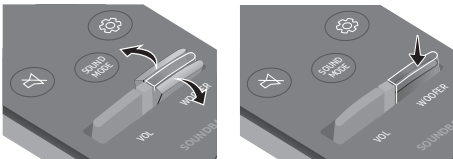

<p>1</p>  <p>Power</p>	<p>Turns the Soundbar on and off.</p> <ul style="list-style-type: none"> • Auto Power Down Function The unit turns off automatically in the following situations: <ul style="list-style-type: none"> - In D.IN / HDMI / Wi-Fi / BT mode if there is no audio signal for 18 minutes.
<p>2</p>  <p>Source</p>	<p>Press to select a source connected to the Soundbar.</p>
<p>3</p>  <p>Mute</p>	<p>Press the  (Mute) button to mute the sound. Press it again to unmute the sound.</p>

<p>4</p>  <p>SOUND MODE</p>	<p>You can select the desired sound mode by choosing STANDARD, SURROUND, GAME PRO, or ADAPTIVE SOUND.</p> <ul style="list-style-type: none"> • STANDARD Outputs the original sound. • SURROUND SOUND Provides a wider sound field than standard. • GAME PRO Provides stereoscopic sound to immerse you in the action while gaming. • ADAPTIVE SOUND Analyzes the content in real time and automatically provides the optimal sound field based on the characteristics of the content.
<p>5</p>  <p>Bluetooth PAIR</p>	<p>Switch the Soundbar to Bluetooth pairing mode. Press the button and wait for the “BT PAIRING” screen to connect to a new Bluetooth device.</p>
<p>6</p>  <p>Play / Pause</p>	<p>You can also play or pause music by pressing the button.</p>
<p>7</p>  <p>Up/Down/Left/Right</p>	 <p>Press the indicated areas to select Up/Down/Left/Right.</p> <p>Press Up/Down/Left/Right on the button to select or set functions.</p> <ul style="list-style-type: none"> • Music Skip Press the Right button to select the next music file. Press the Left button to select the previous music file. • ID SET Use this option when the Subwoofer or Surround Speakers are not connected or need reconnection. While powered off, press and hold the Up button for 5 seconds to perform ID SET. (See page 16.)

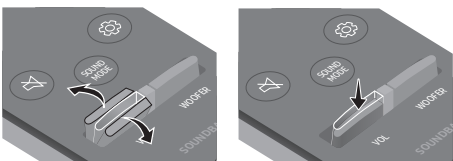
<p>8</p>	 <p>Sound Control</p>	<p>When pressed, the setting items such as TREBLE, BASS, SYNC, CENTER LEVEL, FRONT TOP LEVEL, and VIRTUAL ON/OFF are displayed in sequence. The desired item can be adjusted using the Up/Down buttons.</p> <ul style="list-style-type: none"> - To control the volume of the treble or bass sound, select TREBLE or BASS in Sound Settings, and then adjust the volume between -6~+6 by using the Up/Down buttons. - Press and hold the  (Sound Control) button for about 5 seconds to adjust the sound for each frequency band. 150Hz, 300Hz, 600Hz, 1.2kHz, 2.5kHz, 5kHz, and 10kHz are selectable using the Left/Right buttons and each can be adjusted to a setting between -6 to +6 using the Up/Down buttons. (Make sure the Sound mode is set to "STANDARD".) - To control the volume of the each speaker select CENTER LEVEL, or FRONT TOP LEVEL in Sound Settings, and then adjust the volume between -6~+6 by using the Up/Down buttons. - If the video on the TV and audio from the Soundbar are not synchronised, select SYNC in Sound Control, and then set the audio delay between 0~300 milliseconds by using the Up/Down buttons. - SYNC is only supported for some functions. - If Surround Speakers are connected, select REAR LEVEL and then use the Up/Down buttons to adjust the volume within a -6 to +6 range. - The VIRTUAL Speaker function can be turned ON/OFF by using the Up/Down buttons.
<p>9</p>	 <p>WOOFER (BASS) LEVEL</p>	 <p>Push the button up or down to adjust the level of the woofer (bass) to -12 or between -6 to +6. To set the woofer (bass) volume level to 0 (Default), press the button.</p>
<p>10</p>	 <p>VOLUME</p>	 <p>Push the button up or down to adjust the volume.</p> <ul style="list-style-type: none"> • Mute Press the VOL button to mute the sound. Press it again to unmute the sound.

Using the Hidden Buttons (Buttons with more than one function)

Hidden Button		Reference page
Remote Control Button	Function	
WOOFER (Up)	TV remote control On/Off (Standby)	page 13
Up	ID SET	page 16
 (Sound Control)	7 Band EQ	page 11

Output specifications for the different sound effect modes

Effect	Input	Output	
		With Subwoofer Only	With Subwoofer & Wireless Rear Speaker Kit
STANDARD	2.0 ch	2.1 ch	2.1 ch
	5.1 ch	3.1 ch	5.1 ch
SURROUND	2.0 ch	3.1.2 ch	5.1.2 ch
	5.1 ch	3.1.2 ch	5.1.2 ch
GAME PRO	2.0 ch	3.1.2 ch	5.1.2 ch
	5.1 ch	3.1.2 ch	5.1.2 ch
ADAPTIVE SOUND	2.0 ch	3.1.2 ch	5.1.2 ch
	5.1 ch	3.1.2 ch	5.1.2 ch







- For input sources Dolby Atmos and DTS:X, the effect modes that can be selected using the **SOUND MODE** button will not be available. (See above for the effect modes.)
- When the input source is Dolby Atmos®, the Subwoofer-only setup provides 3.1.2 channel audio, while the Subwoofer & Wireless Rear Speaker Kit setup provides 5.1.2 channel audio.
- The Samsung Wireless Rear Speaker Kit can be purchased separately. To purchase a Kit or the Subwoofer, contact the vendor you purchased the Soundbar from.
- The Surround Speakers will not produce sounds for 2 channel output while **STANDARD** mode is in use. To enable sound for the Surround Speakers, change the effect mode to **SURROUND**.

Adjusting the Soundbar volume with a TV remote control

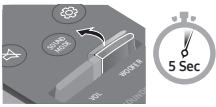
Adjust the Soundbar volume using the TV's remote control.

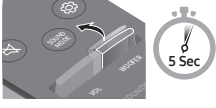
- This function can be used with IR remote controls only. Bluetooth remote controls (remote controls that require pairing) are not supported.
- Set the TV speaker to **External Speaker** to use this function.
- Manufacturers supporting this function:
VIZIO, LG, Sony, Sharp, PHILIPS, PANASONIC, TOSHIBA, Hisense, RCA

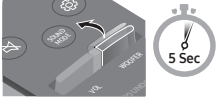
1. Turn Off the Soundbar.
2. Push up and hold the **WOOFER** button for 5 seconds.
Each time you push the **WOOFER** button up and hold it for 5 seconds, the mode switches in the following order: "**SAMSUNG-TV REMOTE**" (Default mode), "**OFF-TV REMOTE**", "**ALL-TV REMOTE**".

Remote Control Button	Display	Status
	(Default mode) 	Enable a Samsung TV's IR remote control.
		Disable the TV remote control.
		Enable a third-party TV's IR remote control.

04 CONNECTING THE SOUNDBAR

Connecting the power and units

Use the power components to connect the Subwoofer and Soundbar to an electrical outlet in the following order:

- For more information about the required electrical power and power consumption, refer to the label attached to the product. (Label: Bottom of the Soundbar Main Unit)

1. Connect the Power cord to the Subwoofer.

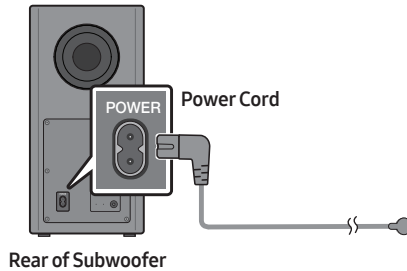

2. First connect the power cable to the AC/DC adapter. Connect the AC/DC adapter (with the power cable) to the Soundbar.

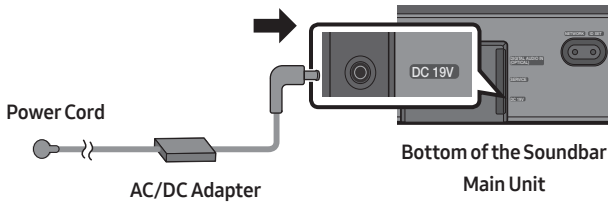

3. Connect power to the Soundbar and Subwoofer. The Subwoofer is automatically connected when the Soundbar is turned on.

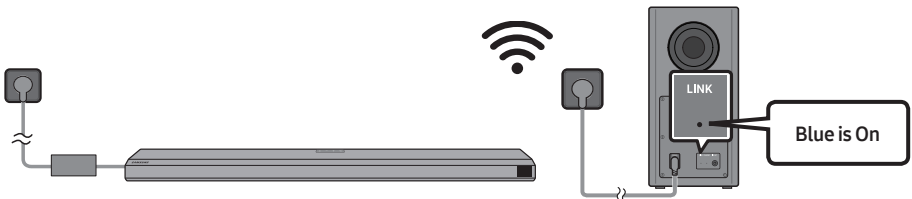

NOTES

- Connect the Subwoofer power before connecting to the Soundbar.
The Subwoofer will be automatically connected when turning on the Soundbar.
- If you unplug and reconnect the power cord when the product is turned on, the Soundbar turns on automatically.
- Make sure to rest the AC/DC Adapter flat on a table or the floor. If you place the AC/DC Adapter so that it is hanging with the AC cord input facing upwards, water or other foreign substances could enter the Adapter and cause the Adapter to malfunction.

Manually connecting the Subwoofer

Before performing the manual connection procedure below:

- Check whether the power cables for the Soundbar and subwoofer are connected properly.
- Make sure that the Soundbar is turned off.

1. Turn off the Soundbar main.
2. Press and hold **ID SET** on the rear of the subwoofer for at least 5 seconds.
 - The red indicator on the rear of the subwoofer turns off and the blue indicator blinks.

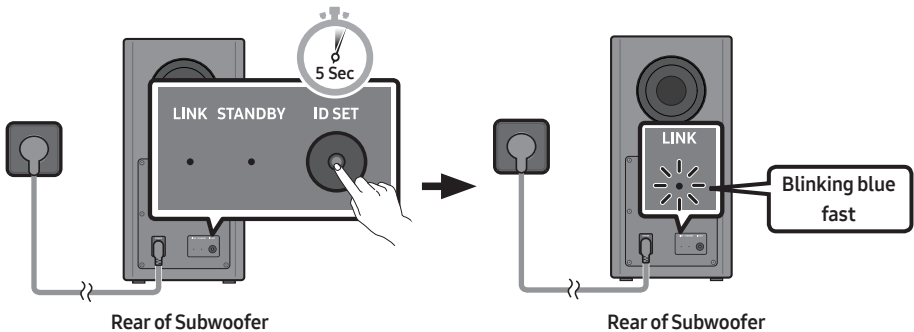

3. Press the **Up** button on the remote control for 5 seconds.
- The **ID SET** message appears on the display of the Soundbar for a moment, and then it disappears.
 - The Soundbar will automatically power on when **ID SET** is complete.

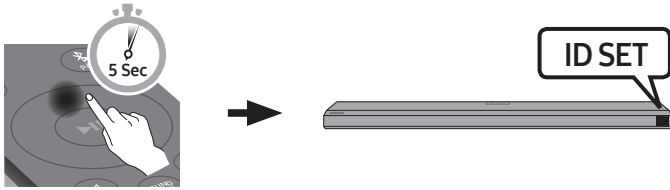

4. Check if the LINK LED is solid blue (connection complete).

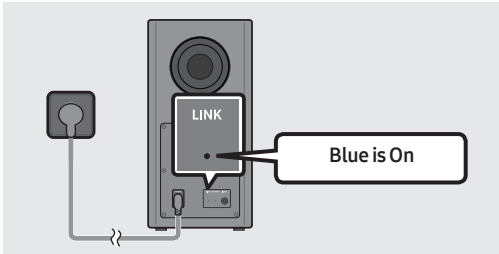

The LINK LED indicator stops blinking and glows a solid blue when a connection is established between the Soundbar and the Wireless Subwoofer.

LED Indicator Lights on the Rear of Subwoofer

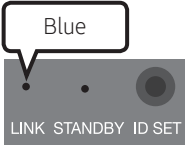
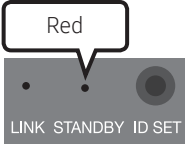
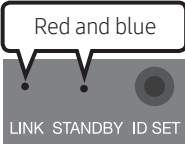
LED	Status	Description	Resolution
	On	Successfully connected (normal operation)	-
	Blinking	Recovering the connection	Check if the power cable attached to the main Soundbar unit is connected properly or wait about 5 minutes. If blinking persists, try manually connecting the subwoofer. See page 15.
	On	Standby (with the Soundbar main unit turned off)	Check if the power cable attached to the main Soundbar unit is connected properly.
		Connection failed	Connect again. See the instructions for manual connection on page 15.
	Blinking	Malfunction	See the contact information for the Samsung Service Centre in this manual.

NOTES

- If the main unit is powered off, the wireless subwoofer will go into stand-by mode and the STANDBY LED on the rear of the sub-woofer will turn red after blinking in blue several times.
- If you use a device that uses the same frequency (5.8GHz) as the Soundbar near the Soundbar, interference may cause some sound interruption.
- The maximum transmission distance of the main unit's wireless signal is about 10 m, but may vary depending on your operating environment. If a steel-concrete or metallic wall is between the main unit and the wireless subwoofer, the system may not operate at all because the wireless signal cannot penetrate metal.

CAUTION

- Wireless receiving antennas are built into the wireless subwoofer. Keep the unit away from water and moisture.
- For optimal listening performance, make sure that the area around the wireless subwoofer and the Wireless Receiver Module (sold separately) is clear of any obstructions.

Connecting an SWA-9000S (Sold Separately) to your Soundbar

Expand to true wireless surround sound by connecting the Samsung Wireless Rear Speaker Kit (SWA-9000S, sold separately) to your Soundbar.

1. Connect the Wireless Receiver Module to 2 Surround Speakers.
 - The speaker cables are colour coded.

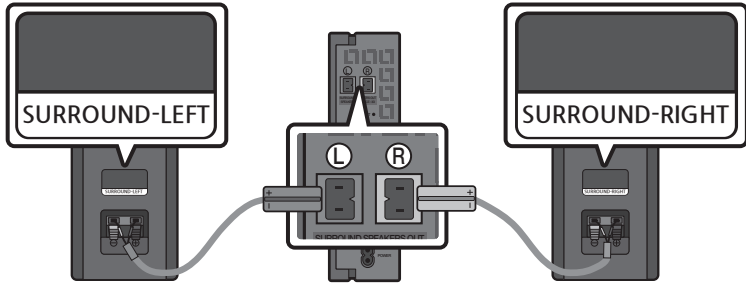

2. Check the standby status of the Wireless Receiver Module after plugging it into an electrical outlet.
 - The LINK LED indicator (blue) on the Wireless Receiver Module should be blinking. If the indicator does not blink, use a narrow pin to press and hold the **ID SET** button for 5 seconds or longer. See the SWA-9000S user guide for more details.

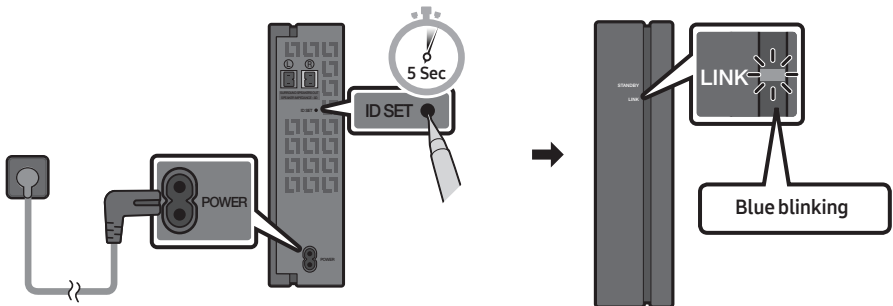

3. Press the **Up** button on the remote control for 5 seconds.
- The **ID SET** message appears on the display of the Soundbar for a moment, and then it disappears.
 - The Soundbar will automatically power on when **ID SET** is complete.

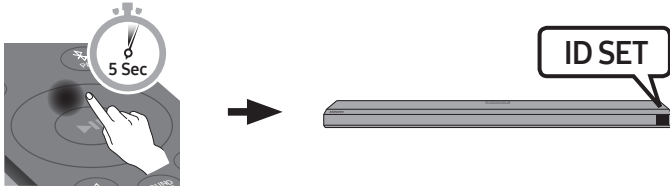

CAUTION

- If your Soundbar was playing music when it connects to the SWA-9000S, you may hear some stuttering from the woofer as the connection finalises.
4. Check if the LINK LED is solid blue (connection complete).

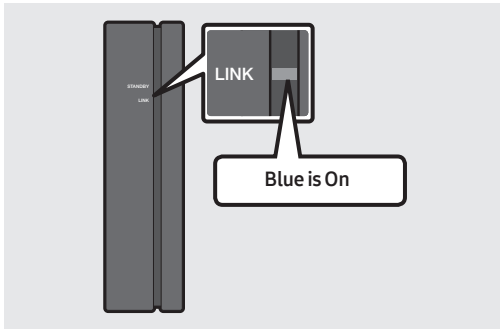

The LINK LED indicator stops blinking and glows a solid blue when a connection is established between the Soundbar and the Wireless Receiver Module.

5. If the SWA-9000S is not connected, repeat the procedure from Step 2.

05 USING A WIRED CONNECTION TO THE TV

Method 1. Connecting with HDMI

⚠ CAUTION

- When both the HDMI cable and optical cable are connected, the HDMI signal is received first.
- To connect the HDMI cable between the TV and Soundbar, be sure to connect the terminals marked ARC. Otherwise, the TV sound may not be output.
- Be sure to use the cable with the premium HDMI certification logo. In addition, make sure that the cable is a certified Type A, high-speed HDMI Ethernet cable. (HIGH SPEED HDMI CABLE WITH ETHERNET)

Connecting the TV that supports HDMI ARC (Audio Return Channel)

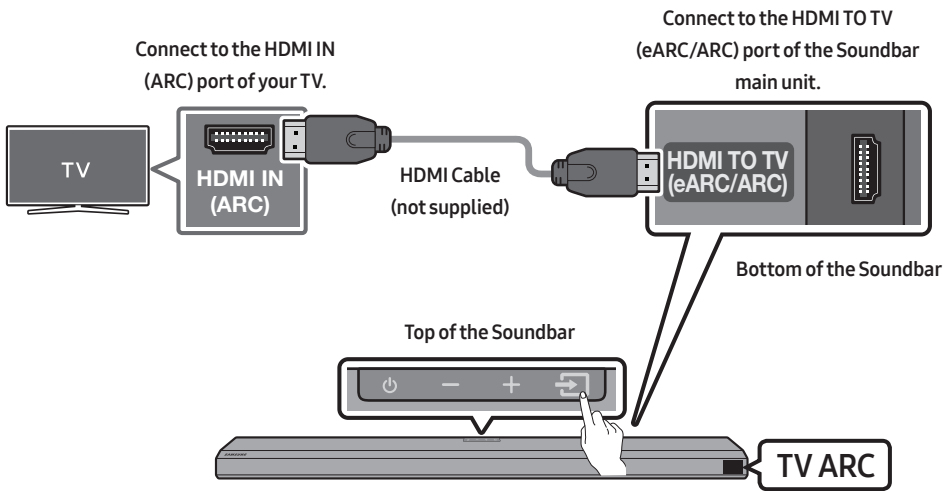

1. With the Soundbar and TV turned off, connect the HDMI cable (not supplied) as shown in the figure.
2. Turn on the Soundbar and TV.
3. **"TV ARC"** appears in the display window of the Soundbar main unit and the Soundbar plays TV sound.
 - If TV sound is inaudible, press the  (**Source**) button on the remote control or on the top of the Soundbar to switch to **"D.IN"** mode. The screen displays **"D.IN"** and **"TV ARC"** in sequence, and TV sound is played.

- When connecting a Samsung TV that supports the eARC function, “**eARC**” appears on the display and the sound is heard.
- If “**TV ARC**” does not appear in the display window of the Soundbar main unit, confirm that the HDMI cable (not supplied) is connected to the correct port.
- Use the volume buttons on the TV’s remote control to change the volume on the Soundbar.

NOTES

- When you connect the TV that supports the HDMI ARC (Audio Return Channel) to the Soundbar with an HDMI cable, you can transmit the digital video and audio data without connecting a separate optical cable.
- We recommend you use a coreless HDMI cable if possible. If you use a cored HDMI cable, use one whose diameter is less than 14 mm.
- This function is not available if the HDMI cable does not support ARC.
- When the audio in a broadcast is encoded in Dolby Digital and the “Digital Output Audio Format” on your TV is set to PCM, we recommend that you change the setting to Dolby Digital. When the setting on the TV is changed, you will experience better sound quality. (The TV menu may use different words for Dolby Digital and PCM depending on the TV manufacturer.)

Method 2. Connecting using an Optical Cable

Pre-connection Checklist

- When both the HDMI cable and optical cable are connected, the HDMI signal is received first.
- When you use an optical cable and the terminals have covers, be sure to remove the covers.

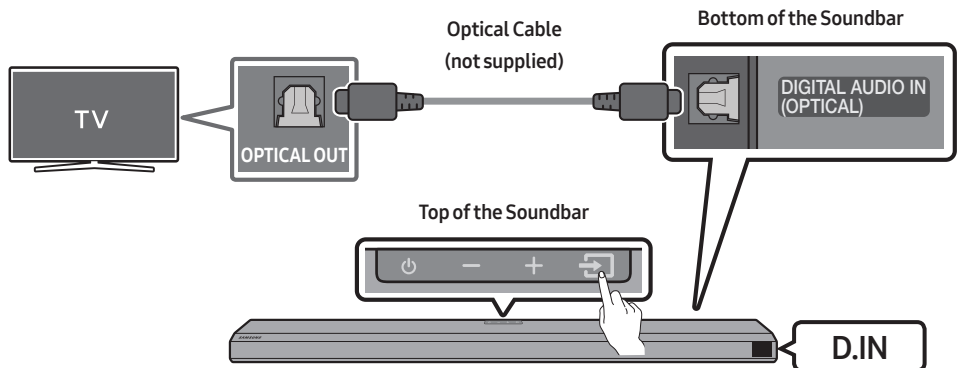

1. With the TV and Soundbar turned off, connect the **DIGITAL AUDIO IN (OPTICAL)** port on the Soundbar and the OPTICAL output port on the TV with the optical cable (not supplied), as shown in the figure.
2. Turn on the Soundbar and TV.
3. Press the  (**Source**) button on the top panel or remote control, and then select the “**D.IN**” mode.
4. The TV sound is output from the Soundbar.

Using the Q-Symphony Function

For Q-Symphony, the Soundbar syncs with a Samsung TV to output sound through two devices for optimum surround effect. When the Soundbar is connected, the menu, “**TV+Soundbar**” appears under the **Sound Output** menu of the TV. Select the corresponding menu.

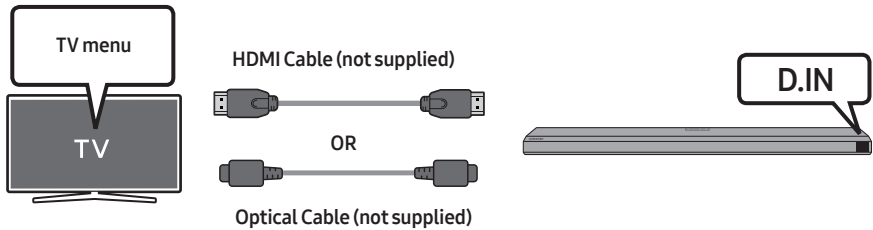

- TV menu example: **TV series name + [AV] Soundbar series name (HDMI)**

NOTES

- It can operate according to the Codec supported by TV.
- This function is supported only when the HDMI Cable (not supplied) or Optical Cable (not supplied) is connected.
- This function is available in Samsung TVs released in 2020 and some Soundbar models.

06 USING A WIRELESS CONNECTION TO THE TV

Connecting via Bluetooth

When a Samsung TV is connected using Bluetooth, you can hear stereo sound without the hassle of cabling.

- Only one Samsung TV can be connected at a time.
- Samsung TV that supports Bluetooth can be connected. Check the specifications of your TV.

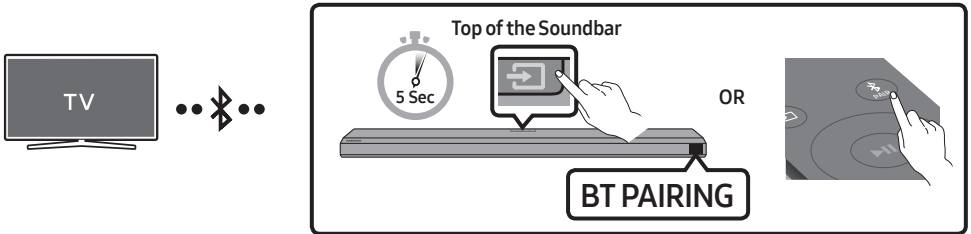

The initial connection

1. Press the **PAIR** button on the Soundbar remote control to enter the **"BT PAIRING"** mode.

(OR) a. Press the **Source** button on the top panel and then select **"BT"**.

"BT" changes to **"BT PAIRING"** in a few seconds automatically or changes to **"BT READY"** if there is a connect record.

- b. When **"BT READY"** appears, press and hold the **Source** button on the top panel of the Soundbar for more than 5 seconds to display **"BT PAIRING"**.

2. Select Bluetooth mode on the Samsung TV.

(e.g. Home (🏠) → Settings (⚙️) → Sound → Sound Output → Bluetooth Speaker List → [AV] Samsung Soundbar Q70T (Bluetooth))

3. Select **"[AV] Samsung Soundbar Q70T"** from the list on TV's screen.

An available Soundbar is indicated with **"Need Pairing"** or **"Paired"** on the TV's Bluetooth device list. To connect the Samsung TV to the Soundbar, select the message, and then establish a connection.

- When the Samsung TV is connected, [TV Name] → **"BT"** appears on the Soundbar's front display.

4. You can now hear Samsung TV sound from the Soundbar.

- After you have connected the Soundbar to your Samsung TV the first time, use the **"BT READY"** mode to reconnect.

If the device fails to connect

- If you have an existing Soundbar (e.g., [AV] Samsung Soundbar Q70T) on the list of speakers on the Samsung TV, delete it.
- Then repeat steps 1 through 3.

Disconnecting the Soundbar from the Samsung TV

Press the  (**Source**) button on the top panel or on the remote control and switch to any mode but “BT”.

- Disconnecting takes time because the Samsung TV must receive a response from the Soundbar. (The time required may differ, depending on the Samsung TV model.)

What is the difference between BT READY and BT PAIRING?

- **BT READY** : In this mode, you can reconnect any Samsung TV or mobile device that was connected before.
- **BT PAIRING** : In this mode, you can connect a new device to the Soundbar.
(Press the  **PAIR** button on the Soundbar remote control or press and hold the  (**Source**) button on the top of the Soundbar for more than 5 seconds while the Soundbar is in “BT” mode.)

Notes on Bluetooth connection

- Locate a new device within 1 m to connect via Bluetooth communication.
- If asked for a PIN code when connecting a Bluetooth device, enter <0000>.
- The Soundbar automatically turns off after 18 minutes in the Ready state.
- The Soundbar may not perform Bluetooth search or connection correctly under the following circumstances:
 - If there is a strong electrical field around the Soundbar.
 - If several Bluetooth devices are simultaneously paired with the Soundbar.
 - If the Bluetooth device is turned off, not in place, or malfunctions.
- Electronic devices may cause radio interference. Devices that generate electromagnetic waves must be kept away from the Soundbar main unit - e.g., microwaves, wireless LAN devices, etc.

07 CONNECTING AN EXTERNAL DEVICE

Method 1. Connecting using an HDMI Cable (Capable of Dolby Atmos decoding and playback)

Pre-connection Checklist

- Dolby Atmos® and DTS:X are supported in HDMI mode only.
- If the Audio Output options include Secondary Audio, make sure Secondary Audio is set to Off.
- Make sure that the content supports Dolby Atmos®.

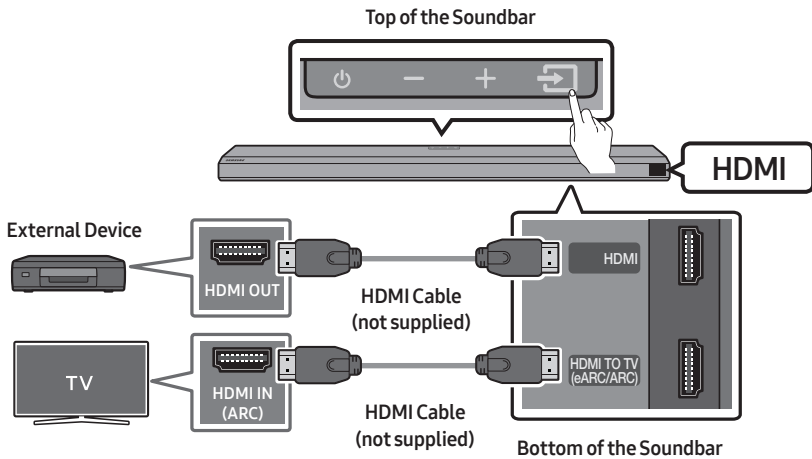



1. Use an HDMI cable (not supplied) to connect the HDMI OUT port on the external device and the **HDMI** port on the bottom of the Soundbar.
2. Use an HDMI cable (not supplied) to connect the HDMI IN port of the TV and the **HDMI TO TV (eARC/ARC)** port on the bottom of the Soundbar.
3. Turn on the Soundbar, TV, and the external device.
4. Press the  (**Source**) button on the top panel or on the remote control, and then select "**HDMI**".
5. The Soundbar display indicates that "**HDMI**" mode is currently selected and the Soundbar will start playing sounds.

NOTES

- **When you use Dolby Atmos®:** If the input source is Dolby Atmos®, 5.1.2 channels are outputted. When Dolby Atmos® is active, the Soundbar's sound effect modes controlled by the **SOUND MODE** button are not available.
- When Dolby Atmos® is activated, "**DOLBY ATMOS**" appears in the front display.
- **Configuring Dolby Atmos® on your BD player or other device.**
Open the audio output options on the settings menu of your BD player or other device and make sure that "No Encoding" is selected for Bitstream. For example, on a Samsung BD Player, go to Home Menu → Sound → Digital Output and then select Bitstream (unprocessed).

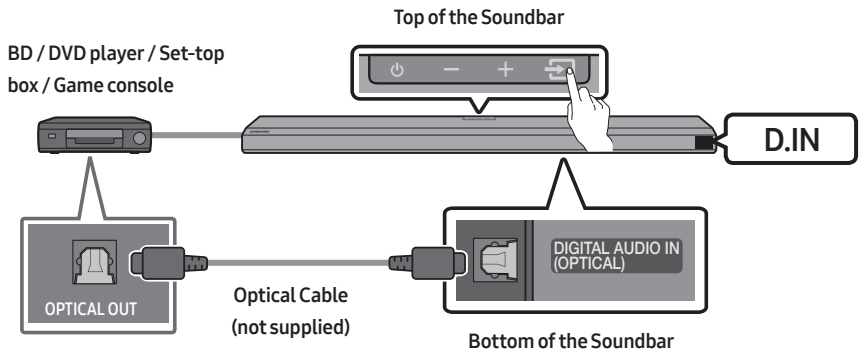
Method 2. Connecting using an Optical Cable



1. Use an optical cable (not supplied) to connect the **DIGITAL AUDIO IN (OPTICAL)** on the Soundbar main and the **OPTICAL OUT** port on the external device.
2. Turn on the Soundbar and external device.
3. Select "**D.IN**" mode by pressing the  (**Source**) button on the top panel or on the remote control.
4. Your Soundbar will play sounds from the external device.

08 CONNECTING A MOBILE DEVICE

Method 1. Connecting via Bluetooth

When a mobile device is connected using Bluetooth, you can hear stereo sound without the hassle of cabling.

- When you connect a paired Bluetooth device with the Soundbar off, the Soundbar automatically turns on.

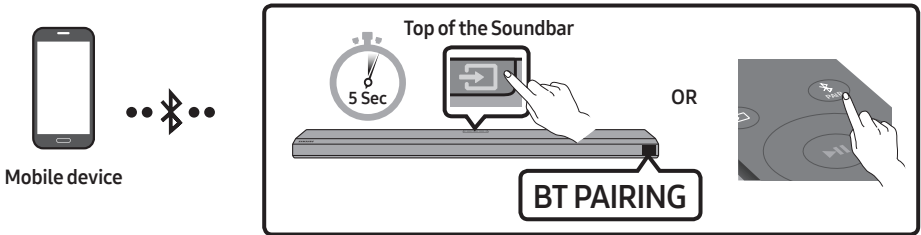

The initial connection

- When connecting to a new Bluetooth device, make sure the device is within 1 m distance.
1. Press the **PAIR** button on the Soundbar remote control to enter the “**BT PAIRING**” mode.
(OR)
 - a. Press the **Source** button on the top panel and then select “**BT**”.
“**BT**” changes to “**BT PAIRING**” in a few seconds automatically or changes to “**BT READY**” if there is a connect record.
 - b. When “**BT READY**” appears, press and hold the **Source** button on the top panel of the Soundbar for more than 5 seconds to display “**BT PAIRING**”.
 2. On your device, select “[AV] Samsung Soundbar Q70T” from the list that appears.
 - When the Soundbar is connected to the Mobile device, [Mobile Device Name] → “**BT**” appears in the front display.
 3. Play music files from the device connected via Bluetooth through the Soundbar.
 - After you have connected the Soundbar to your mobile device the first time, use the “**BT READY**” mode to reconnect.

If the device fails to connect

- If you have an existing Soundbar (e.g., “[AV] Samsung Soundbar Q70T”) in the list of speakers on the Mobile device, delete it.
- Repeat steps 1 and 2.

What is the difference between BT READY and BT PAIRING?

- **BT READY** : In this mode, you can reconnect any Samsung TV or mobile device that was connected before.
- **BT PAIRING** : In this mode, you can connect a new device to the Soundbar.
(Press the  **PAIR** button on the Soundbar remote control or press and hold the  **(Source)** button on the top of the Soundbar for more than 5 seconds while the Soundbar is in "BT" mode.)

Notes on Bluetooth connection

- Locate a new device within 1 m to connect via Bluetooth communication.
- If asked for a PIN code when connecting a Bluetooth device, enter <0000>.
- The Soundbar automatically turns off after 18 minutes in the Ready state.
- The Soundbar may not perform Bluetooth search or connection correctly under the following circumstances:
 - If there is a strong electrical field around the Soundbar.
 - If several Bluetooth devices are simultaneously paired with the Soundbar.
 - If the Bluetooth device is turned off, not in place, or malfunctions.
- Electronic devices may cause radio interference. Devices that generate electromagnetic waves must be kept away from the Soundbar main unit - e.g., microwaves, wireless LAN devices, etc.
- The Soundbar supports SBC data (44.1kHz, 48kHz).
- Connect only to a Bluetooth device that supports the A2DP (AV) function.
- You cannot connect the Soundbar to a Bluetooth device that supports only the HF (Hands Free) function.
- When connecting the Soundbar to a Bluetooth device, place them as close to each other as possible.
- The farther the Soundbar and Bluetooth device are from each other, the lower the sound quality will become.
The Bluetooth connection may break when the devices are out of the effective range.
- The Bluetooth connection may not function as intended in areas with poor reception.
- A Bluetooth device may experience noise or malfunction under in the following conditions:
 - When the body is in contact with the signal transceiver on the Bluetooth device or Soundbar
 - In corners or when there is an obstacle in proximity, such as a wall or partition, where electrical changes may occur.
 - When exposed to radio interferences by other products operating on the same frequency ranges, such as medical equipment, microwave ovens, and wireless LAN devices.
 - Obstacles such as doors and walls may still impact the sound quality even when the devices are within the effective range.

- Note that your Soundbar cannot be paired with other Bluetooth devices while using the Bluetooth option.
- This wireless device may cause electrical interference during operation.

Disconnecting the Bluetooth device from a Soundbar

You can disconnect a Bluetooth device from the Soundbar. For instructions, see the Bluetooth device's user manual.

- The Soundbar will be disconnected.
- When the Soundbar is disconnected from the Bluetooth device, the Soundbar will display "**BT DISCONNECTED**" on the front display.

Disconnecting the Soundbar from the Bluetooth device

Press the  (**Source**) button on the top panel or on the remote control, and then change to any mode except "**BT**".

- Disconnecting takes time because the Bluetooth device must receive a response from the Soundbar. (Disconnection time may differ, depending on the Bluetooth device)
- When the Soundbar is disconnected from the Bluetooth device, the Soundbar will display "**BT DISCONNECTED**" on the front display.

Method 2. Connecting via Wi-Fi (Wireless Network)

To connect a Soundbar to a mobile device via a wireless network (Wi-Fi), the **SmartThings** app is required.

The initial connection

1. Install and launch the **SmartThings** app from your mobile device (smartphone or tablet).
2. On the app, follow the screen instructions to add the Soundbar.
 - The automatic pop-up (the second screenshot below) may not show on some devices. If the pop-up does not appear, press “+” on the **Home** screen. The Soundbar is added to the app.

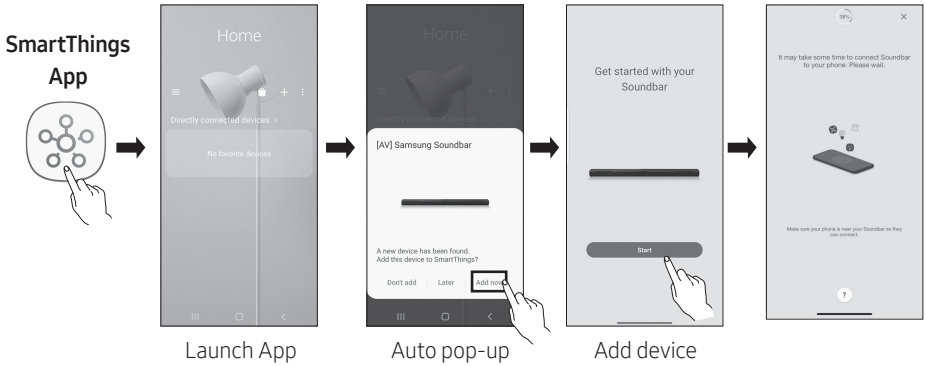

09 CONNECTING AN AMAZON PRODUCT

- This feature may not be available in some countries.
- This service is provided by Amazon and can be terminated at any time. Samsung does not assume responsibility for service availability.
- **Amazon Alexa** app screen is subject to change without prior notice.

Connect and use with an Amazon product (Amazon Echo)

Use an Amazon Echo product to control your Soundbar and enjoy music services provided by Amazon Echo.

NOTE

- Confirm that the Soundbar is connected to Wi-Fi. (Refer to "Method 2. Connecting via Wi-Fi (Wireless Network)")

Use voice commands to control the Soundbar

- The Amazon Echo service you can use with your Soundbar is limited to music. Other services provided by Amazon Echo, such as news and weather, can only be accessed through your Amazon Echo product.



Trigger + Command + Speaker name

* To use voice commands for the Soundbar named "Living room"

Action	Voice Command
To set the volume level to 5	"Alexa Set the volume to 5 on Living room"
To increase the volume level	"Alexa Volume up on Living room"
To mute the sound	"Alexa Mute on Living room"
To listen to a radio station named KISS FM	"Alexa Play Kiss FM on Living room"
To play the next song	"Alexa Next song on Living room"
To stop the audio	"Alexa Stop on Living room"
To turn the audio off	"Alexa Turn off on Living room"

Using the Tap Sound

Tap the Soundbar with your mobile device to play the sound of content on the mobile device through the Soundbar.

- This function may not be supported, depending on the mobile device.
- This function is only compatible with Samsung mobile devices with Android 8.1 or later.

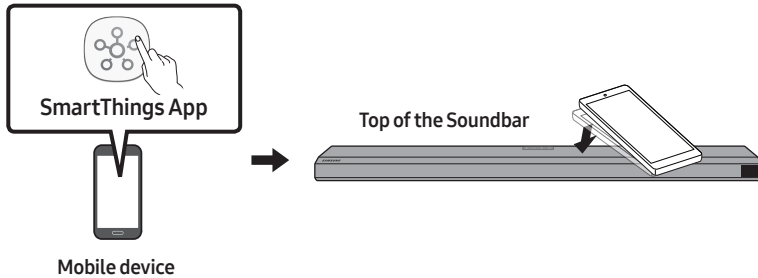

1. Turn on the **Tap Sound** function on your mobile device.
 - For details on how to turn on the function, refer to “**Setting the Tap Sound function**” below.
2. Tap the Soundbar with the mobile device. Select “**Start now**” in the displayed message window. A connection is established between the mobile device and Soundbar via Bluetooth.
3. Play the sound of content on the mobile device through the Soundbar.
 - This function connects a mobile device to the Soundbar via Bluetooth by detecting vibration that occurs when the device touches the Soundbar.
 - Make sure the mobile device does not tap a sharp corner of the Soundbar. The Soundbar or mobile device may become scratched or damaged.
 - It is recommended that the mobile device be covered with a case. Lightly tap the wide area in the upper portion of the Soundbar, without using excessive force.
 - To use this function, update the **SmartThings** app to the latest version. The function may not be supported, depending on the app version.

Setting the Tap Sound function

Use the **SmartThings** app to turn on the **Tap View, Tap Sound** function.

1. On the mobile device, run the **SmartThings** app.
2. Select (☰ → ⚙) in the **SmartThings** app screen displayed on the mobile device.
3. Set “**Tap View, Tap Sound**” to On to allow the function to work when a mobile device moves close to the Soundbar. The function is turned on.

NOTES

- When the mobile device is in power-saving mode, the **Tap Sound** function does not work.
- The **Tap Sound** function may not work if there are devices near the Soundbar that cause radio interference such as electric devices. Make sure devices that may cause radio interference are placed at a sufficient distance away from the Soundbar.

10 INSTALLING THE WALL MOUNT

Installation Precautions

- Install on a vertical wall only.
- Do not install in a place with high temperature or humidity.
- Verify whether the wall is strong enough to support the product's weight. If not, reinforce the wall or choose another installation point.
- Purchase and use the fixing screws or anchors appropriate for the kind of wall you have (plaster board, iron board, wood, etc.). If possible, fix the support screws into wall studs.
- Purchase wall mounting screws according to the type and thickness of the wall you want to mount the Soundbar on.
 - Diameter: M5
 - Length: 35 mm or longer recommended.
- Connect cables from the unit to external devices before you install the Soundbar on the wall.
- Make sure the unit is turned off and unplugged before you install it. Otherwise, it may cause an electric shock.

Wallmount Components

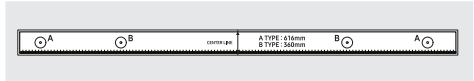

Wall Mount Guide



x 2

Holder-Screw



x 2

(M4 x L10)

Screw

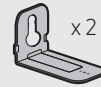

x 2

Bracket-Wall Mount

1. Place the **Wall Mount Guide** against the wall surface.
 - The **Wall Mount Guide** must be level.
 - If your TV is mounted on the wall, install the Soundbar at least 5 cm below the TV.

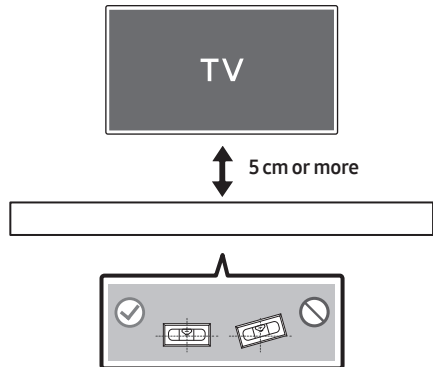

2. Align the **Wall Mount Guide's Centre Line** with the centre of your TV (if you are mounting the Soundbar below your TV), and then fix the **Wall Mount Guide** to the wall using tape.

- If you are not mounting below a TV, place the **Centre Line** in the centre of the installation area.

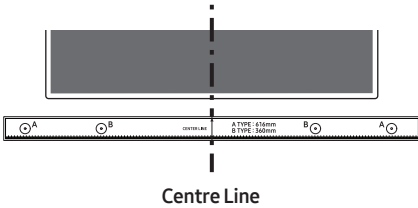

3. Push a pen tip or sharpened pencil tip through the centre of the **A-TYPE** images on each end of the Guide to mark the holes for the supporting screws, and then remove the **Wall Mount Guide**.

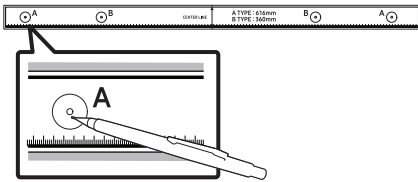

4. Using an appropriately sized drill bit, drill a hole in the wall at each marking.

- If the markings do not correspond to the positions of studs, make sure you insert appropriate anchors or mollies into the holes before you insert the support screws. If you use anchors or mollies, make sure the holes you drill are large enough for the anchors or mollies you use.

5. Push a screw (not supplied) through each **Holder-Screw**, and then screw each screw firmly into a support screw hole.

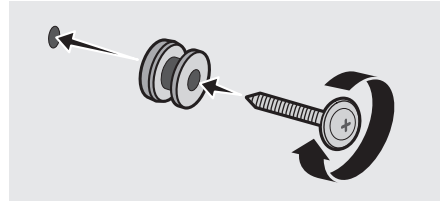

6. Install the 2 **Bracket-Wall Mounts** in the correct orientation on the bottom of the Soundbar using 2 **Screws**.

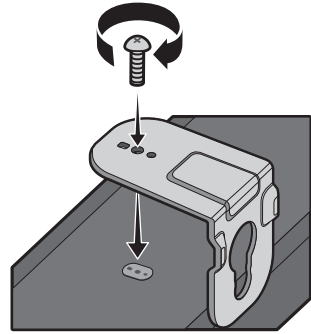

- When assembling, make sure the hanger part of the **Bracket-Wall Mounts** are located behind the rear of the Soundbar.

Rear of Soundbar

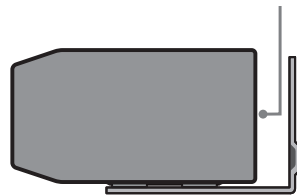

Right end of Soundbar

7. Install the Soundbar with the attached **Bracket-Wall Mounts** by hanging the **Bracket-Wall Mounts** on the **Holder-Screws** on the wall.

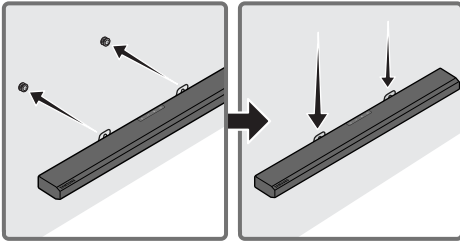

8. Slide the Soundbar down as shown below so that the **Bracket-Wall Mounts** rest securely on the **Holder-Screws**.

- Insert the **Holder-Screws** into the wide (bottom) part of the **Bracket-Wall Mounts**, and then slide the **Bracket-Wall Mounts** down so that the **Bracket-Wall Mounts** rest securely on the **Holder-Screws**.

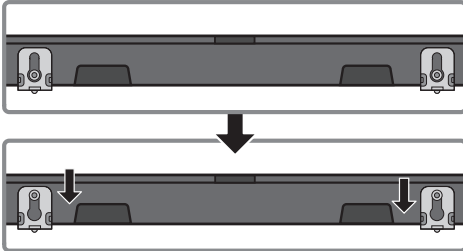

11 INSTALLING THE SOUNDBAR ABOVE A TV STAND

Component

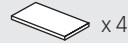

x 4

Rubber-Foot

To install, attach the **Rubber-Feet** to the bottom of the Soundbar before placing it in position above the TV stand. Make sure you attach the **Rubber-Feet** so that they are beyond the outside edges of the TV stand. Refer to the figure below.

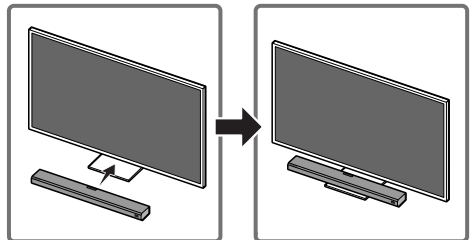
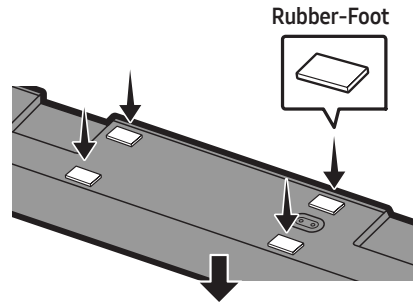

Place the Soundbar on a TV stand.

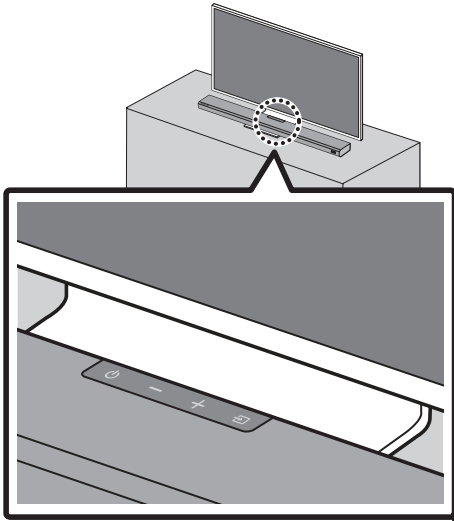

As illustrated in the image, align the center of the Soundbar with the center of the TV, carefully place the Soundbar onto the TV stand.

NOTES

- Make sure the Soundbar is placed on a flat and solid surface.
- Insufficient gap from the TV may cause acoustic problem.

12 SOFTWARE UPDATE

Auto Update

When the Soundbar is connected to the Internet, software updates automatically occur even when the Soundbar is turned off.

- To use the Auto Update function, the Soundbar must be connected to the Internet. The Wi-Fi connection to the Soundbar will be terminated if the Soundbar's power cord is disconnected or the power is cut off. If the power is cut off, when the power comes back on or you reconnect the power cord, turn on the Soundbar, and then reconnect it to the Internet.

USB Update

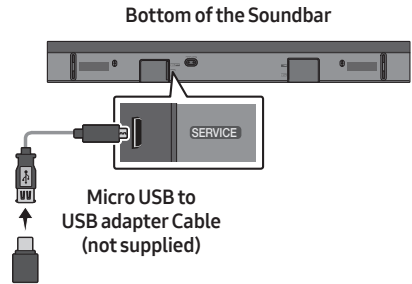

Samsung may offer updates for the Soundbar's system firmware in the future.

When an update is available, you can update the Soundbar by connecting the USB drive that contains the update firmware to the **SERVICE** port of the Soundbar.

1. Go to the Samsung website (www.samsung.com) → search for the model name from the customer support menu option.
 - For more information about update, refer to Upgrade Guide.
2. Download the upgrade file (USB type).
3. Unzip the file to create a folder with the file name.
4. Store the created folder in a USB and then connect it to the Soundbar.
5. Turn on the Soundbar. Then the product is updated within 3 minutes with displaying the message, “**UPDATE**”.
 - During update, do not turn it off or remove the USB.
 - If “**UPDATE**” does not appear on the display window, remove the power cord from the Soundbar and then reconnect it.
 - When the latest version is installed, no update is performed.
 - Depending on the USB type, update may not be supported.

Initialisation

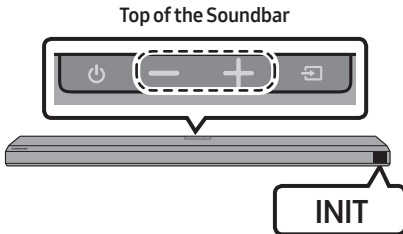

With the Soundbar on, press the **— + (Volume)** buttons on the body at the same time for at least 5 seconds. “**INIT**” appears on the display and then the Soundbar is initialised.

CAUTION

- All the settings of the Soundbar are initialised. Be sure to perform this only when initialisation is required.

13 TROUBLESHOOTING

Before seeking assistance, check the following.

In case the power is not turned on

- Check whether the power cord of the Soundbar is correctly inserted into the outlet.

In case the functions do not work properly

- After removing the power cord, insert it again.
- Remote the power cord from the external device and try again.
- If there is no signal, the Soundbar automatically turns off after a certain period of time. Turn on the power. (See page 9.)

In case the remote control does not work

- Operate the remote control noting the Soundbar closely.
- Replace the batteries with new ones.

In case the Soundbar sound is not output

- The volume of the Soundbar is too low or muted. Adjust the volume.
- When any external device (STB, Bluetooth device, mobile device, etc.) is connected, adjust the volume of the external device.
- For sound output of the TV, select Soundbar. (Samsung TV: Home (🏠) → Settings (⚙️) → Sound → Sound Output → Select Soundbar)

- The cable connection to the Soundbar may not be loose. Remove the cable and connect again.
- Remove the power cord completely, reconnect, and turn the power on.
- Initialise the product and try again. (See page 37.)

In case the sound of the Subwoofer speaker is not output

- Check whether the LED indicator on the rear of the Subwoofer is on in blue. Reconnect the Soundbar and Subwoofer if the indicator is blinking in blue or turned red. (See page 15.)
- You may experience an issue if there is an obstacle between the Soundbar and Subwoofer. Move devices to an area away from obstacles.
- Other devices sending radio frequency signals in proximity may interrupt the connection. Keep your speaker away from such devices.
- Remove and reconnect the power plug.

The Subwoofer volume is too low

- The original volume of the content you are playing may be low. Try adjusting the Subwoofer level. (See page 11.)
- Bring the Subwoofer speaker closer to you.

In case the TV is not connected via HDMI TO TV (eARC/ARC)

- Check whether the HDMI cable is correctly connected to the ARC terminal. (See page 20.)
- Connection may not be possible due to the connected external device (set-top box, game machine, etc.). Directly connect the Soundbar.
- HDMI-CEC may not be activated on the TV. Turn on the CEC on the TV menu. (Samsung TV: Home (🏠) → Settings (⚙️) → General → External Device Manager → Anynet+ (HDMI-CEC) ON)

There is no sound in when connecting to the TV in HDMI TO TV (eARC/ARC) mode

- Your device is unable to play the input signal. Change the TV's audio output to PCM or Dolby Digital. (For a Samsung TV: Home (🏠) → Settings (⚙️) → Sound → Expert Settings → Digital Output Audio Format)

In case Bluetooth connection is not possible

- When connecting a new device, switch to "BT PAIRING" for connection. (Press the **PAIR** button on the remote control or press the **(Source)** button on the body for at least 5 seconds.)
- If the Soundbar is connected to another device, disconnect that device first to switch the device.
- Reconnect it after removing the Bluetooth speaker list on the device to connect. (Samsung TV: Home (🏠) → Settings (⚙️) → Sound → Sound Output → Bluetooth Speaker List)
- The automatic TV connection may be disabled. While the Soundbar is in "BT READY", press and hold the **▶||** button on the Soundbar remote control for 5 seconds to select **ON-TV CONNECT**. If you see **OFF-TV CONNECT**, press and hold **▶||** button again for 5 seconds to switch the selection.

- Remove and reconnect the power plug, then try again.
- Initialise the product and try again. (See page 37.)

In case Bluetooth sound breaking occurs

- Sounds may be breaking due to interference by radio frequency or electronic devices nearby. Keep such devices away from the Soundbar to avoid radio interference. Example: microwave ovens.
- Because the device to connect is far away from the Soundbar, sound breaking may occur. Move the device near the Soundbar.
- If a part of your body is in contact with the Bluetooth transceiver or the product is installed on metal furniture, sound breaking may occur. Check the installation environment and conditions for use.

In case Wi-Fi connection is not possible

- Check whether your wireless router is on.
- Turn off the router, turn it back on, and then try again.
- When the signal of the wireless router is too weak, connection may not be possible. Move the router near the Soundbar or adjust the installed position with no obstacles.
- If your wireless router is new, you will need to reconfigure the speaker's network settings.

In case the Soundbar is not turned on as soon as the TV is turned on

- When you turn off the Soundbar while watching TV, power synchronization with the TV is disabled. First turn off the TV.

14 LICENCE



Manufactured under license from Dolby Laboratories. Dolby, Dolby Atmos, Dolby Audio, Dolby Digital Plus, Pro Logic, and the double-D symbol are trademarks of Dolby Laboratories.



For DTS patents, see <http://patents.dts.com>. Manufactured under license from DTS Licensing Limited. DTS, the Symbol, & DTS and the Symbol together, DTS:X, and the DTS:X logo are registered trademarks and/or trademarks of DTS, Inc. in the United States and/or other countries. © DTS, Inc. All Rights Reserved.



The terms HDMI and HDMI High-Definition Multimedia Interface, and the HDMI Logo are trademarks or registered trademarks of HDMI Licensing LLC in the United States and other countries.



- The Spotify Software is subject to third party licenses found here : www.spotify.com/connect/third-party-licenses.
 - For more information about Spotify Connect, please visit www.spotify.com/connect
-

15 OPEN SOURCE LICENCE NOTICE

To send inquiries and requests for questions regarding open sources, contact Samsung Open Source (<http://opensource.samsung.com>)

16 IMPORTANT NOTES ABOUT SERVICE

- Figures and illustrations in this User Manual are provided for reference only and may differ from actual product appearance.
- An administration fee may be charged if either
 - (a) an engineer is called out at your request and there is no defect with the product (i.e. where the user manual has not been read).
 - (b) you bring the unit to a repair centre and there is no defect with the product (i.e. where the user manual has not been read).
- You will be informed of the administration fee amount before a technician visits.

17 SPECIFICATIONS AND GUIDE

Specifications

Model Name	HW-Q70T
Weight	3.6 kg
Dimensions (W x H x D)	980.0 x 60.0 x 115.0 mm
Operating Temperature Range	+5°C to +35°C
Operating Humidity Range	10 % ~ 75 %
AMPLIFIER Rated Output power	(30W x 4) + (20W x 2) + 10W + 160W
Supported play formats	Dolby Atmos (True HD / Digital Plus), Dolby Digital, DTS Master Audio, DTS:X, DTS
WIRELESS DEVICE OUTPUT POWER Wi-Fi max transmitter power	100mW at 2.4GHz – 2.4835GHz, 200mW at 5.15GHz – 5.25GHz, 100mW at 5.25GHz – 5.35GHz & 5.47GHz – 5.725GHz
WIRELESS DEVICE OUTPUT POWER BT max transmitter power	100mW at 2.4GHz – 2.4835GHz
WIRELESS DEVICE OUTPUT POWER SRD max transmitter power	25mW at 5.725GHz – 5.825GHz

Subwoofer Name	PS-WR65BC
Weight	6.2 kg
Dimensions (W x H x D)	205.0 x 353.0 x 303.0 mm
AMPLIFIER Rated Output power	160W
WIRELESS DEVICE OUTPUT POWER SRD max transmitter power	25mW at 5.725GHz – 5.825GHz

NOTES

- Samsung Electronics Co., Ltd reserves the right to change the specifications without notice.
- Weight and dimensions are approximate.

Precaution : The Soundbar will restart automatically if you turn on/turn off Wi-Fi.

Overall Standby Power Consumption (W)	5.2W
Wi-Fi Port deactivation method	Press the ID SET button on the bottom panel of the Soundbar for 30 seconds to turn Wi-Fi On / Off.
Bluetooth Port deactivation method	Press the NETWORK button on the bottom panel of the Soundbar for 30 seconds to turn Bluetooth On / Off.

- Hereby, Samsung, declares that this equipment is in compliance with Directive 2014/53/EU.

The full text of the EU declaration of conformity is available at the following internet address: <http://www.samsung.com> go to Support > Search Product Support and enter the model name.

This equipment may be operated in all EU countries.

The 5GHz WLAN(Wi-Fi or SRD) function of this equipment may only be operated indoors.





[Correct disposal of batteries in this product]

(Applicable in countries with separate collection systems)

This marking on the battery, manual or packaging indicates that the batteries in this product should not be disposed of with other household waste at the end of their working life. Where marked, the chemical symbols Hg, Cd or Pb indicate that the battery contains mercury, cadmium or lead above the reference levels in EC Directive 2006/66.

If batteries are not properly disposed of, these substances can cause harm to human health or the environment.

To protect natural resources and to promote material reuse, please separate batteries from other types of waste and recycle them through your local, free battery return system.



Correct Disposal of This Product (Waste Electrical & Electronic Equipment)

(Applicable in countries with separate collection systems)

This marking on the product, accessories or literature indicates that the product and its electronic accessories (e.g. charger, headset, USB cable) should not be disposed of with other household waste at the end of their working life. To prevent possible harm to the environment or human health from uncontrolled waste disposal, please separate these items from other types of waste and recycle them responsibly to promote the sustainable reuse of material resources.

Household users should contact either the retailer where they purchased this product, or their local government office, for details of where and how they can take these items for environmentally safe recycling.

Business users should contact their supplier and check the terms and conditions of the purchase contract. This product and its electronic accessories should not be mixed with other commercial wastes for disposal.

For information on Samsung's environmental commitments and product specific regulatory obligations e.g. REACH, WEEE, Batteries, visit:
http://www.samsung.com/uk/aboutsamsung/samsungelectronics/corporatecitizenship/data_corner.html

COMMISSION REGULATION (EU) 2019/1782

Ecodesign requirements for external power supplies :
www.samsung.com/global/ecodesign_component



UNITED KINGDOM



EIRE

This Samsung product is warranted for the period of twelve (12) months from the original date of purchase, against defective materials and workmanship. In the event that warranty service is required, you should return the product to the retailer from whom it was purchased. However, Samsung Authorised Dealers and Authorised Service Centres in other EC Countries will comply with the warranty on the terms issued to purchasers in the country concerned. In case of difficulty, details of our Authorised Service Centres are available from:

Samsung Electronics U.K. Ltd
Samsung Customer Support Centre
Selectapost 38, Sheffield, S97 3FJ
United Kingdom

United Kingdom
Tel : 0333 000 0333
www.samsung.com/uk/support

EIRE
Tel : 0818 717100
www.samsung.com/ie/support

■ WARRANTY CONDITIONS

1. The warranty is only valid if, when warranty service is required, the warranty card is fully and properly completed and is presented with the original invoice or sales slip or confirmation, and the serial number on the product has not been defaced.
2. Samsung's obligations are limited to the repair or, at its discretion, replacement of the product or the defective part.
3. Warranty repairs must be carried out by Authorised Samsung Dealers or Authorised Service Centres. No re-imburement will be made for repairs carried out by non Samsung Dealers and, any such repair work and damage to the products caused by such repair work will not be covered by this warranty.
4. This product is not considered to be defective in materials nor workmanship by reason that it requires adaptation in order to conform to national or local technical or safety standards in force in any Country other than the one for which the product was originally designed and manufactured. This warranty will not cover, and no re-imburement will be made for such adaptation nor any damage which may result.
5. This warranty covers none of the following:
 - a) Periodic check ups, maintenance and repair or replacement of parts due to normal wear and tear.
 - b) Cost relating to transport, removal or installation of the product.
 - c) Misuse, including the failure to use this product for its normal purposes or incorrect installation.
 - d) Damage caused by Lightning, Water, Fire, Acts of God, War, Public Disturbances, incorrect mains voltage, improper ventilation or any other cause beyond the control of Samsung.
6. This warranty is valid for any person who legally acquired possession of the product during the warranty period.
7. The consumers statutory rights in any applicable national legislation whether against the retailer arising from the purchase contract or otherwise are not affected by this warranty. Unless there is national legislation to the contrary, the rights under this warranty are the consumers sole rights and Samsung, its subsidiaries and distributors shall not be liable for indirect or consequential loss or any damage to records, compact discs, videos or audio taper or any other related equipment or material.

SAMSUNG ELECTRONICS (U.K.) LTD.

© 2020 Samsung Electronics Co., Ltd. All rights reserved.

Contact SAMSUNG WORLD WIDE

If you have any questions or comments relating to Samsung products, please contact the SAMSUNG customer care Centre.

Area	Contact Centre ☎	Web Site	Area	Contact Centre ☎	Web Site
■ Europe					
UK	0333 000 0333	www.samsung.com/uk/support	CZECH	800 - SAMSUNG (800-726786)	www.samsung.com/cz/support
IRELAND (EIRE)	0818 717100	www.samsung.com/ie/support	SLOVAKIA	0800 - SAMSUNG (0800-726 786)	www.samsung.com/sk/support
GERMANY	06196 77 555 77	www.samsung.com/de/support	CROATIA	072 726 786	www.samsung.com/hr/support
FRANCE	01 48 63 00 00	www.samsung.com/fr/support	BOSNIA	055 233 999	www.samsung.com/support
ITALIA	800-SAMSUNG (800.7267864)	www.samsung.com/it/support	NORTH MACEDONIA	023 207 777	www.samsung.com/mk/support
SPAIN	91 175 00 15	www.samsung.com/es/support	MONTENEGRO	020 405 888	www.samsung.com/support
PORTUGAL	808 207 267	www.samsung.com/pt/support	SLOVENIA	080 697 267 (brezplačna številka)	www.samsung.com/si/support
LUXEMBURG	261 03 710	www.samsung.com/be_fr/support	SERBIA	011 321 6899	www.samsung.com/rs/support
NETHERLANDS	088 90 90 100	www.samsung.com/nl/support	KOSOVO	0800 10 10 1	www.samsung.com/support
BELGIUM	02-201-24-18	www.samsung.com/be/support (Dutch) www.samsung.com/be_fr/support (French)	ALBANIA	045 620 202	www.samsung.com/al/support
NORWAY	21629099	www.samsung.com/no/support	BULGARIA	*3000 Цена на един градски разговор 0800 111 31 Безплатен за всички оператори	www.samsung.com/bg/support
DENMARK	707 019 70	www.samsung.com/dk/support	ROMANIA	*8000 (apel în rețea) 08008-726-78-64 (08008-SAMSUNG) Apel GRATUIT Atenție: Dacă efectuați apelul din rețeaua Digi (RCS/RDS), vă rugăm să ne contactați formând numărul Telverde fără ultimele două cifre, astfel: 0800872678.	www.samsung.com/ro/support
FINLAND	030-6227 515	www.samsung.com/fi/support	CYPRUS	8009 4000 only from landline, toll free	www.samsung.com/gr/support
SWEDEN	0771 726 786	www.samsung.com/se/support	GREECE	80111-SAMSUNG (80111 726 7864) only from land line (+30) 210 6897691 from mobile and land line	
POLAND	801-172-678* lub +48 22 607-93-33* Specjalistyczna infolinia do obsługi zapytań dotyczących telefonów komórkowych: 801-672-678* * (opłata według taryfy operatora)	http://www.samsung.com/pl/support/	LITHUANIA	8-800-77777	www.samsung.com/lt/support
HUNGARY	0680SAMSUNG (0680-726-7864)	www.samsung.com/hu/support	LATVIA	8000-7267	www.samsung.com/lv/support
AUSTRIA	0800 72 67 864 (0800-SAMSUNG)	www.samsung.com/at/support	ESTONIA	800-7267	www.samsung.com/ee/support
SWITZERLAND	0800 726 786	www.samsung.com/ch/support (German) www.samsung.com/ch_fr/support (French)			