

User Guide

Doorbell Pro 2

ring



Included installation hardware.

Bag Hardware

A



(2) 1-3/8" Long Mounting Screws



(2) Wall Anchors

B



(2) 3/16" Security Screws

C



(2) 5/8" Short Mounting Screws

D



(2) Wire Nuts



(2) Wire Extenders



(1) Alt Pro Power Kit Cables



Don't have an existing doorbell? You can power your Doorbell Pro 2 directly using our Plug-in Adapter. Visit ring.com/accessories to learn more.

Download the Ring App.

The Ring App walks you through setting up and managing your Ring Doorbell.

Search for "Ring" in one of the app stores below, or visit ring.com/app



Set up your Ring Doorbell.

In the Ring app, select **Set Up a Device** and follow the in-app instructions.

Find your doorbell chime.

Your Doorbell Pro 2 is designed to replace an existing doorbell button, and gets its power from the doorbell system.

Ring your existing doorbell and listen for the chime. If it rings, we know your existing doorbell system is working.

Follow the sound to find your chime and make a mental note of the location. We'll return to your chime soon.

Turn off power at the breaker.

This is essential to keeping you and your new Ring Doorbell safe.

If you're not sure which breaker controls your doorbell chime, turn off the master breaker for your home, or contact an electrician.



CAUTION!

You'll be working with electrical wires during the install process.

If you are uncomfortable or inexperienced with doing so, consult with a licensed electrician.

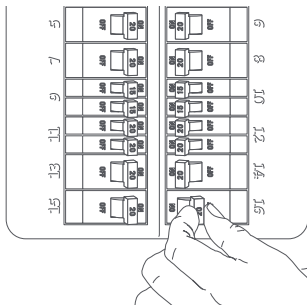

Grab the included Pro Power Kit.

You must install this in your doorbell chime. It's not a transformer or power adapter. Remove and replace any existing Pro Power Kit.



Input Requirements



	MIN	MAX
Voltage:	16VAC	24VAC
Power:	10VA	40VA
Frequency:	50Hz	60Hz



WARNING.

Do not connect your Pro Power Kit directly to the electrical main. Doing so could result in FIRE, ELECTRIC SHOCK, or OTHER INJURY or DAMAGE.

Remove the cover from your doorbell chime.

After you've turned off power at the breaker, remove the cover from your chime and set it aside for now.

Loosen the "Front" and "Trans" terminal screws.

Make sure to keep the existing doorbell wires in place.

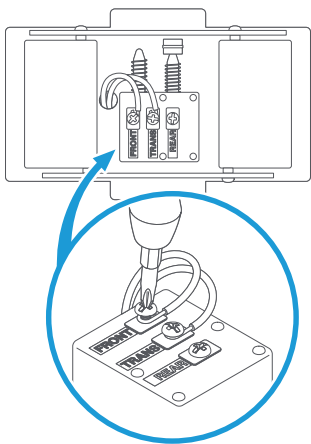

Connect the Pro Power Kit wires.

Connect one wire from the Pro Power Kit to the "Front" terminal, and the other to the "Trans" terminal. It doesn't matter which wire you connect to which terminal. Then re-tighten the terminal screws.

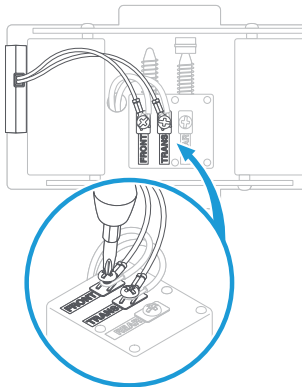

Position the Pro Power Kit and replace the cover.

Place it within your internal doorbell, away from any moving parts.

Uninstall your existing doorbell button.

Remove your doorbell from the wall. Disconnect the wires. Make sure they don't fall back inside your wall so you can access them later.

Remove the faceplate.

Grasp the bottom of the faceplate and pull to remove.

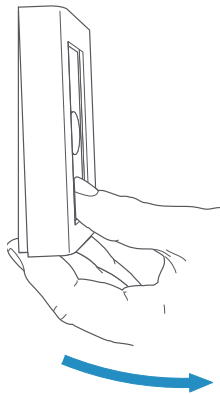

Install the included Corner Mount. (optional)

The Corner Mount can angle your Ring Doorbell to improve motion detection and provide a better view.

Mark two mounting holes on your wall through the slots on your Corner Mount (fig 1).

If you are replacing a Ring Doorbell, align the two small screw holes with two of the existing holes in your wall (fig 2).

(Skip to page 15 if you don't plan on using the Corner Mount.)

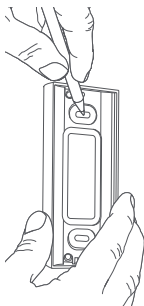

fig. 1

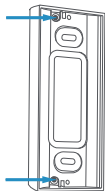

fig. 2

Install the anchors. (optional)

On stucco, brick, or concrete, use a 1/4" masonry bit to drill holes in your wall, then insert the included wall anchors.

(If you're installing on wood or siding, you can skip this step.)



DO NOT USE any screw other than the included long mounting screws when securing your Ring Doorbell.

Screw in the Corner Mount.

Using the long mounting screws, secure the Corner Mount to the wall through the slots (fig. 3).

If you're re-using existing holes, secure it with the adjacent screw holes (fig. 4).

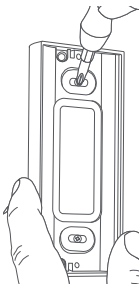

fig. 3

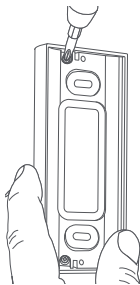

fig. 4



1-3/8" Long
mounting
screw



5/8" Short
mounting
screw



3/16"
Security
screw

Connect the doorbell wires.

Loop one doorbell wire around each of the screw terminals on the rear of your Ring Doorbell then tighten the terminals to secure.

If your doorbell wires are too short to reach your new Ring Doorbell, you can attach the included wire extenders using the included wire nuts.

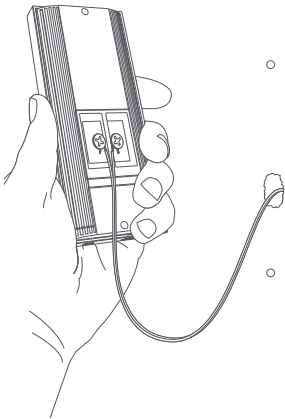

Mount your Ring Doorbell to the Corner Mount.

Secure your Ring Doorbell to the Corner Mount with the two included short mounting screws.

Be sure to feed any excess wiring back into the wall first. If you used the wire nuts, push them through the hole as well.

Once you're done, skip ahead to page 19.



DO NOT USE any screw other than the included short mounting screws when securing your Ring Doorbell.

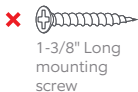
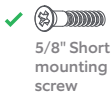
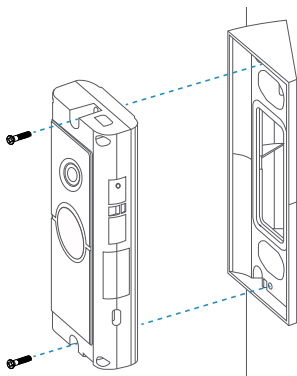

Mark the screw holes.

Using your Ring Doorbell as a template, mark the location of the two mounting holes on your wall.

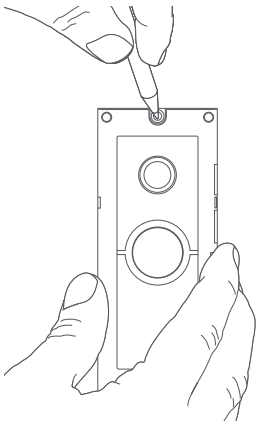

Install the anchors. (optional)

On stucco, brick, or concrete, use a 1/4" masonry bit to drill holes in your wall, then insert the included wall anchors.

(If you're installing on wood or siding, you can skip this step.)



Connect the doorbell wires.

Loop one doorbell wire around each of the screw terminals on the rear of your Ring Doorbell then tighten the terminals to secure.

If your doorbell wires are too short to reach your new Ring Doorbell, you can attach the included wire extenders using the included wire nuts.

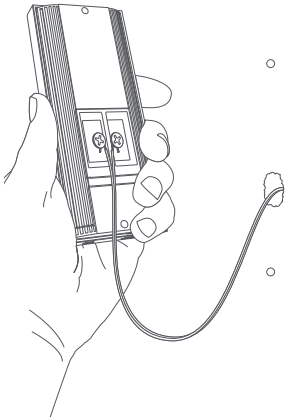

Screw in your Ring Doorbell.

Mount your Ring Doorbell with the two included long mounting screws.

Be sure to feed any excess wiring back into the wall first. If you used the wire nuts, push them through the hole as well.



DO NOT USE any screw other than the included long mounting screws when securing your Ring Doorbell.

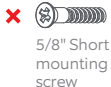
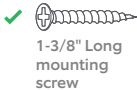
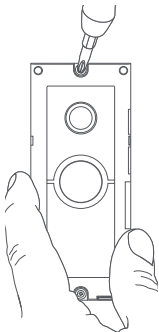

Restore power at the breaker.

It may take a moment for your Ring Doorbell to power on. You'll know it's ready once it lights up and speaks to you.

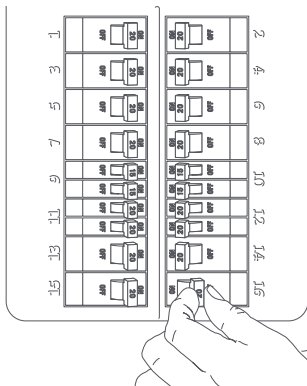

Secure your Ring Doorbell.



Re-attach the faceplate, then use the included screwdriver to drive the small security screw into the bottom of your Ring Doorbell.



CAUTION!

If you use the wrong screws to secure the Video Doorbell, you could damage the battery during installation, create a fire hazard, and be seriously injured.



- ✓  3/16" Security screw
- ✗  1-3/8" Long mounting screw
- ✗  5/8" Short mounting screw

Review, share and download.

Your new device comes with a free 30-day trial of **Ring Protect** video recording service.

To continue your subscription and save your videos, please visit ring.com/protect-plans



What is Ring Protect?

Ring Protect is a subscription service that stores videos from your Ring devices.

Why do I want it?

Ring lets you interact with visitors and monitor your property in real time, while Ring Protect allows you to review and share those videos *anytime*.

How much does it cost?

Ring Protect Basic covers one Ring device for \$3 USD/month or \$30 USD/year.*

Ring Protect Plus covers all Ring devices at one property, and costs \$10 USD/month or \$100 USD/year.**

How do I sign up?

Simply log into your Ring account at ring.com/protect-plans, and follow the on-screen instructions.

*\$5 CAD per month or \$50 CAD per year

**\$15 CAD per month or \$150 CAD per year



For additional help, visit ring.com/help

Or give us a call:

[US 1 800 656 1918](tel:18006561918)

[Canada 1 855 300 7289](tel:18553007289)

[Worldwide +1 310 929 7085](tel:+13109297085)

For a list of all our customer support numbers, visit ring.com/callus

For information on our warranty, theft protection, and Ring Protect Plans, see ring.com/legal

© 2020 Ring LLC or its affiliates.

Ring and all related marks are trademarks of Ring LLC or its affiliates.

