

Always here to help you

Register your product and get support at
www.philips.com/welcome

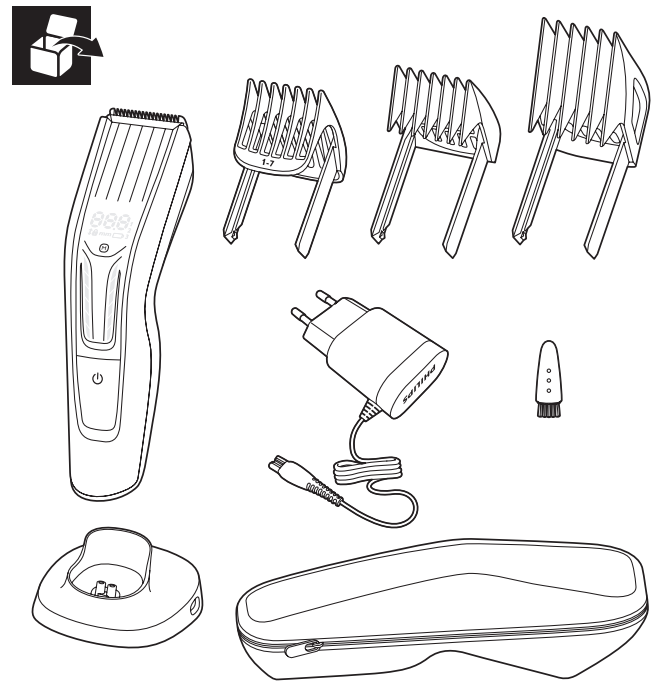

HC9450/20

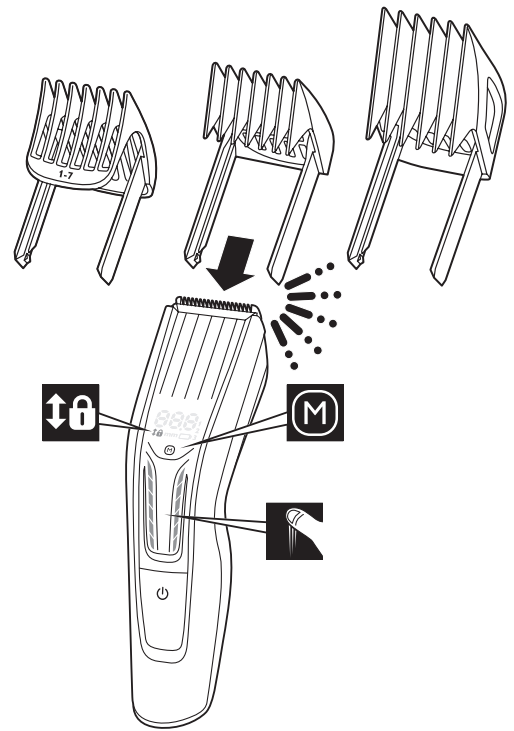

PHILIPS

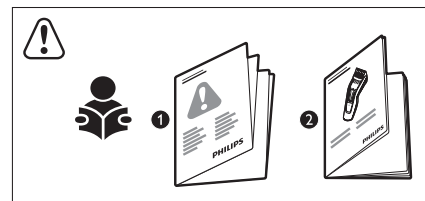

www.philips.com

100% recycled paper
100% papier recyclé

4222.002.8570.1

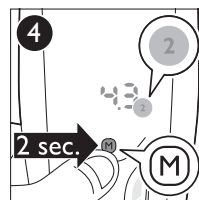
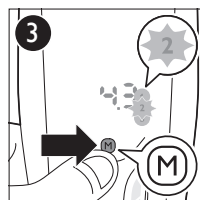
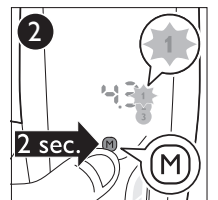
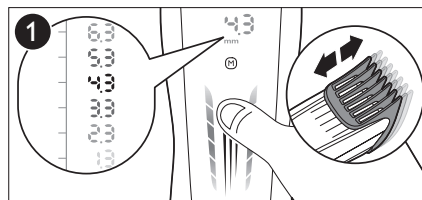
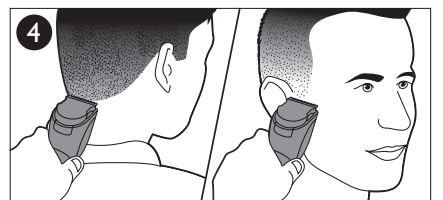
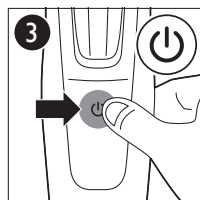
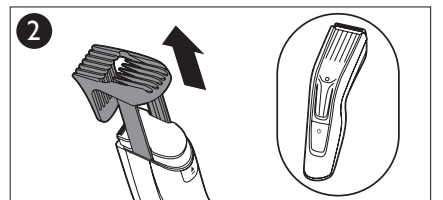
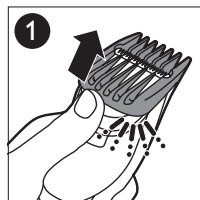
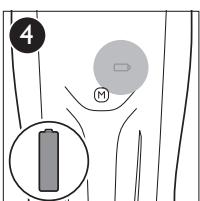
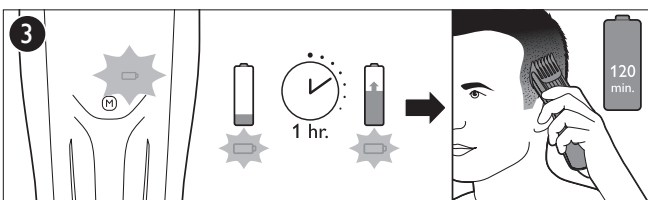
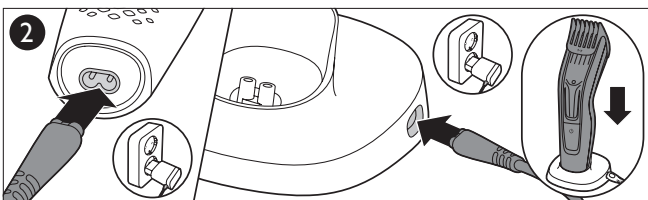
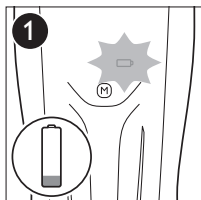
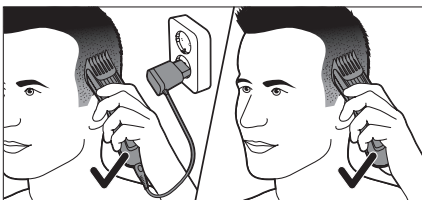
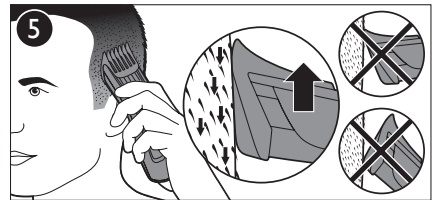
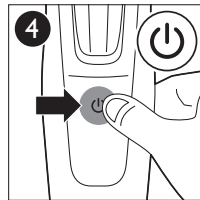
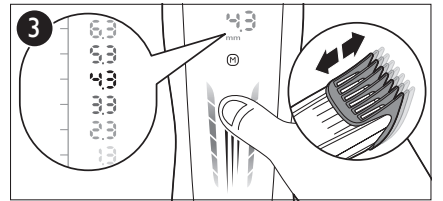
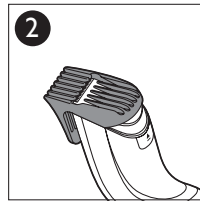
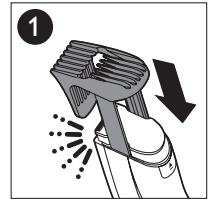
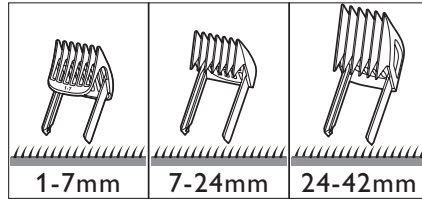
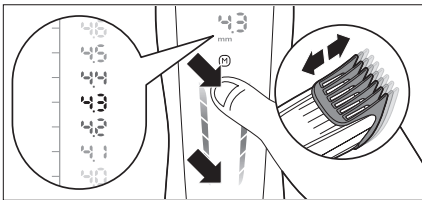
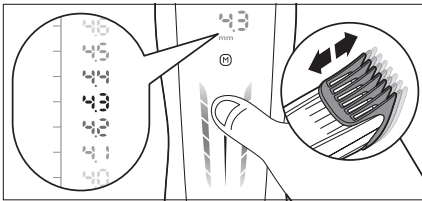
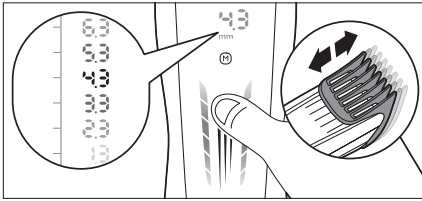

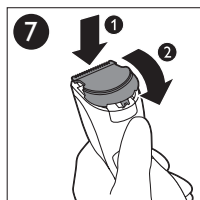
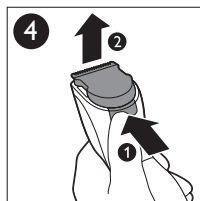
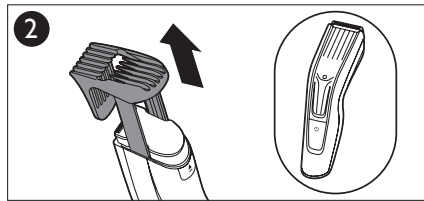
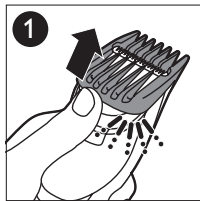
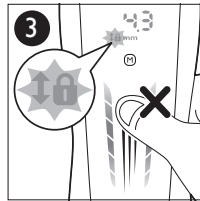
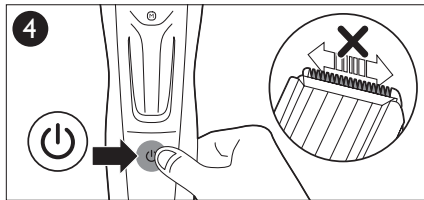
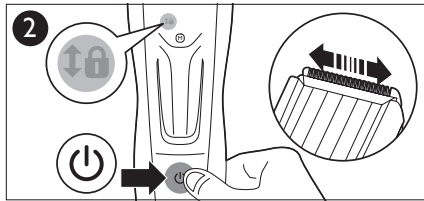
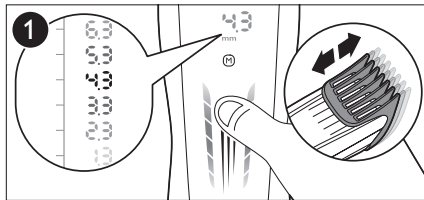

ENGLISH



There are 3 ways to go through the length settings:

- Quickly swipe your thumb or a finger across the touch area to scroll through the length settings quickly.
- Slowly swipe your thumb or a finger across the touch area to scroll through the length settings slowly.
- Tap on the bottom or top part of the touch area to go through the length settings one by one. To scroll through the length settings automatically in steps of 0.1mm, tap and hold the bottom or top part of the touch area.



Memory:

The memory allows you to save 3 lengths per comb. To select a memorised length, press the 'M' button. To switch between memory settings, press the 'M' button. To save a length setting in the memory, press the 'M' button for 2 seconds.



Length lock:

You can only change the length setting if the appliance is switched off.

DANSK



Du kan gå igennem længdeindstillingerne på tre måder:

- Stryk hurtigt med fingeren langs med touchområdet for at rulle hurtigt igennem længdeindstillingerne.
- Stryk langsomt med fingeren langs med touchområdet for at rulle langsomt igennem længdeindstillingerne.
- Tryk på nederste eller øverste del af touchområdet for at gå igennem længdeindstillingerne én ad gangen. Hold den nederste og øverste del af touchområdet nede for at rulle automatisk igennem længdeindstillingerne i trin på 0,1 mm.



Hukommelse:

Hukommelsen giver dig mulighed for at spare tre længder pr. kam. Tryk på knappen "M" for at vælge en længde fra hukommelsen. Tryk på knappen "M" for at skifte mellem hukommelsesindstillingerne. Tryk på knappen "M" i to sekunder for at spare en længdeindstilling i hukommelsen.



Længdelås:

Du kan kun ændre længdeindstillingen, hvis apparatet er slukket.

DEUTSCH



Es gibt drei Möglichkeiten, die Schnittlängeneinstellungen durchzugehen:

- Wischen Sie mit Ihrem Daumen oder Finger schnell über den Touch-Bereich, um schnell durch die Schnittlängeneinstellungen zu blättern.
- Wischen Sie mit Ihrem Daumen oder Finger langsam über den Touch-Bereich, um langsam durch die Schnittlängeneinstellungen zu blättern.
- Tippen Sie oben oder unten auf den Touch-Bereich, um die Schnittlängeneinstellungen Schritt für Schritt durchzugehen. Um die Schnittlängeneinstellungen automatisch in Schritten von 0,1 mm durchzublätern, halten Sie den oberen oder unteren Teil des Touch-Bereichs gedrückt.



Speicher:

Der Speicher ermöglicht das Speichern von 3 Schnittlängeneinstellungen pro Kammaufsatz. Um eine gespeicherte Längeneinstellung auszuwählen, drücken Sie die Taste "M". Um zwischen den Speichereinstellungen zu wechseln, drücken Sie die Taste "M". Um eine Schnittlängeneinstellung abzuspeichern, drücken Sie 2 Sekunden lang die Taste "M".



Längenarretierung:

Sie können die Schnittlängeneinstellung nur ändern, wenn das Gerät ausgeschaltet ist.

ΕΛΛΗΝΙΚΑ



Υπάρχουν 3 τρόποι για να επιλέξετε ρύθμιση μήκους:

- Μετακινήστε γρήγορα τον αντίχειρα ή κάποιο άλλο δάχτυλο κατά μήκος της περιοχής αφής για να περάσετε γρήγορα από όλες τις ρυθμίσεις μήκους.
- Μετακινήστε αργά τον αντίχειρα ή κάποιο άλλο δάχτυλο κατά μήκος της περιοχής αφής για να περάσετε αργά από όλες τις ρυθμίσεις μήκους.
- Πατήστε στο κάτω ή στο επάνω μέρος της περιοχής αφής για να περάσετε από τις ρυθμίσεις μήκους μία προς μία. Για να μετακινηθείτε στις ρυθμίσεις μήκους αυτόματα σε βήματα των 0,1 χιλιοστών, πατήστε παρατεταμένα το κάτω ή το επάνω μέρος της περιοχής αφής.



Μνήμη:

Η μνήμη σας επιτρέπει να αποθηκεύσετε 3 μήκη ανά χτένα. Για να επιλέξετε ένα μήκος αποθηκευμένο στη μνήμη, πατήστε το κουμπί "M". Για να μεταβείτε από τη μια ρύθμιση μνήμης στην άλλη, πατήστε το κουμπί "M". Για να αποθηκεύσετε μια ρύθμιση μήκους στη μνήμη, πατήστε το κουμπί "M" για 2 δευτερόλεπτα.



Κλειδωμα μήκους:

Μπορείτε να αλλάξετε τη ρύθμιση μήκους μόνο όταν η συσκευή είναι απενεργοποιημένη.

ESPAÑOL



Existen 3 formas de desplazarse por las distintas posiciones de longitud:

- Deslice rápidamente el pulgar u otro dedo por la zona táctil para desplazarse por las posiciones de longitud de manera rápida.
- Deslice lentamente el pulgar u otro dedo por la zona táctil para desplazarse por las posiciones de longitud de manera lenta.
- Toque en la parte inferior o superior de la zona táctil para desplazarse por las distintas posiciones de longitud una a una. Para desplazarse automáticamente por las posiciones de longitud en intervalos de 0,1 mm, mantenga pulsada la parte superior o inferior de la zona táctil.



Memoria:

La memoria le permite guardar 3 longitudes por peine-guía. Para seleccionar una longitud guardada en la memoria, pulse el botón "M". Para cambiar entre los ajustes de memoria, pulse el botón "M". Para guardar una posición de longitud en la memoria, pulse el botón "M" durante 2 segundos.



Bloqueo de longitud de corte:

Solo puede cambiar la posición de longitud con el aparato apagado.

SUOMI



Voit selata pituusasetuksia kolmella eri tavalla:

- Selaa pituusasetuksia nopeasti vetämällä peukalolla tai jollain muulla sormella kosketusalueen yli.
- Selaa pituusasetuksia hitaasti vetämällä peukalolla tai jollain muulla sormella kosketusalueen yli hitaasti.
- Selaa pituusasetuksia yksi kerrallaan napauttamalla kosketusalueen ala- tai yläosaa. Voit selata pituusasetuksia automaattisesti 0,1 mm:n välein napauttamalla ja pitämällä pohjassa kosketusalueen ala- tai yläosaa.



Muisti:

Laitteen muistiin voi tallentaa 3 pituusasetusta jokaiselle kammalle. Valitse tallennettu pituusasetus painamalla M-painiketta. Voit vaihtaa muistiasetusten välillä painamalla M-painiketta. Tallenna pituusasetus muistiin painamalla M-painiketta kahden sekunnin ajan.



Length Lock -pituuslukitus:

Voit muuttaa pituusasetusta vain, kun laitteen virta on katkaistu.

FRANÇAIS



Il y a 3 façons de parcourir les réglages de hauteur de coupe :

- Faites glisser rapidement votre pouce ou un doigt sur la zone tactile pour faire défiler rapidement les réglages de hauteur de coupe.
- Faites glisser lentement votre pouce ou un doigt sur la zone tactile pour faire défiler lentement les réglages de hauteur de coupe.
- Appuyez sur le haut ou le bas de la zone tactile pour parcourir les réglages de hauteur de coupe un par un. Pour faire défiler les réglages de hauteur de coupe automatiquement par incrément de 0,1 mm, appuyez et maintenez enfoncé le bas ou le haut de la zone tactile.



Mémoire :

la mémoire vous permet d'enregistrer 3 hauteurs par sabot. Pour sélectionner une hauteur mémorisée, appuyez sur le bouton « M ». Pour basculer entre les réglages de mémoire, appuyez sur le bouton « M ». Pour enregistrer une hauteur de coupe dans la mémoire, appuyez sur le bouton « M » pendant 2 secondes.



Verrou de la hauteur de coupe :

Vous ne pouvez modifier la hauteur de coupe que si l'appareil est éteint.

ITALIANO



Ci sono 3 modi per scorrere le impostazioni della lunghezza:

- Passate velocemente il pollice o un dito sulla superficie tattile per scorrere le impostazioni della lunghezza rapidamente.
- Passate lentamente il pollice o un dito sulla superficie tattile per scorrere le impostazioni della lunghezza lentamente.
- Toccate la parte inferiore o superiore della superficie tattile per scorrere le impostazioni della lunghezza una alla volta. Per scorrere le impostazioni della lunghezza automaticamente in incrementi di 0,1 mm, tenete premuta la parte inferiore o superiore della superficie tattile.



Memoria:

La memoria consente di salvare 3 lunghezze per ciascun pettine. Per selezionare una lunghezza memorizzata, premete il pulsante "M". Per passare da un'impostazione della memoria all'altra, premete il pulsante "M". Per salvare un'impostazione della lunghezza nella memoria, premete il pulsante "M" per 2 secondi.



Blocco della lunghezza:

Potete modificare l'impostazione della lunghezza solo se l'apparecchio è spento.

NEDERLANDS



Er zijn 3 manieren om de lengte-instellingen te bekijken:

- Veeg snel met uw duim of een vinger over het aanraakvlak om snel door de lengte-instellingen te bladeren.
- Veeg langzaam met uw duim of een vinger over het aanraakvlak om langzaam door de lengte-instellingen te bladeren.
- Tik op het onderste of bovenste deel van het aanraakvlak om één voor één door de lengte-instellingen te bladeren. Als u automatisch door de lengte-instellingen wilt bladeren in stappen van 0,1 mm, houd uw vinger dan op het onderste of bovenste deel van het aanraakvlak.



Geheugen:

U kunt per kam 3 standen in het geheugen opslaan. Als u een opgeslagen lengte wilt selecteren, druk dan op de knop 'M'. Als u wilt schakelen tussen geheugeninstellingen, druk dan op de knop 'M'. Als u een lengte-instelling in het geheugen wilt opslaan, druk dan 2 seconden lang op de knop 'M'.



Vergrendeling van de lengtestand:

U kunt de lengte-instelling alleen wijzigen als het apparaat is uitgeschakeld.

NORSK



Det er tre måter å gå gjennom lengdeinnstillingene på:

- Skyv raskt tommelen eller fingeren over berøringsområdet for å bla raskt gjennom lengdeinnstillingene.
- Skyv sakte tommelen eller fingeren over berøringsområdet for å bla sakte gjennom lengdeinnstillingene.
- Trykk på den nederste eller øverste delen av berøringsområdet for å gå gjennom lengdeinnstillingene én om gangen. For å bla gjennom lengdeinnstillingene automatisk i trinn på 0,1 mm kan du trykke på og holde nede den nederste eller øverste delen av berøringsområdet.



Minne:

I minnet kan du lagre tre lengder per kam. Trykk på M-knappen for å velge en lagret lengde. For å veksle mellom innstillinger i minnet trykker du på M-knappen. For å lagre en lengdeinnstilling i minnet trykker du på M-knappen i to sekunder.



Lengdelås:

Du kan bare endre lengdeinnstillingen hvis apparatet er slått av.

PORTUGUÊS



Existem 3 formas para percorrer as regulações de comprimento:

- Passe rapidamente o polegar ou outro dedo pela área tátil para percorrer as regulações de comprimento rapidamente.
- Passe lentamente o polegar ou outro dedo pela área tátil para percorrer as regulações de comprimento lentamente.
- Toque na parte inferior ou na parte superior da área tátil para percorrer as regulações de comprimento uma a uma. Para percorrer as regulações de comprimento automaticamente em intervalos de 0,1 mm, mantenha o dedo sobre a parte inferior ou a parte superior da área tátil.



Memória:

A memória permite-lhe guardar 3 comprimentos por pente. Para seleccionar um comprimento memorizado, prima o botão "M". Para alternar entre as regulações na memória, prima o botão "M". Para guardar uma regulação de comprimento na memória, prima o botão "M" durante 2 segundos.



Bloqueio de comprimento:

Podé alterar a regulação de comprimento apenas com o aparelho desligado.

PORTUGUÊS DO BRASIL



Há 3 formas de percorrer pelos ajustes de altura:

- Passe rapidamente o polegar ou qualquer outro dedo pela área sensível ao toque para percorrer pelos ajustes de altura de modo rápido.
- Lentamente, passe o polegar ou qualquer outro dedo pela área sensível ao toque para percorrer pelos ajustes de altura de maneira mais lenta.
- Toque na parte inferior ou superior da área sensível ao toque para percorrer pelos ajustes de altura, um a um. Para percorrer pelos ajustes de altura automaticamente, em divisões de 0,1 mm, mantenha pressionada a parte inferior ou superior da área sensível ao toque.



Memória:

A memória permite que você salve 3 alturas por pente. Para seleccionar um comprimento memorizado, pressione o botão "M". Para alternar entre os ajustes de memória, pressione o botão "M". Para salvar um ajuste de altura na memória, pressione o botão "M" por 2 segundos.



Trava de altura:

Você só conseguirá alterar o ajuste de altura se o aparelho estiver desligado.

SVENSKA



Du kan gå igenom längdinställningarna på tre sätt:

- Dra tummen eller ett finger snabbt över pekområdet om du vill bläddra igenom längdinställningarna snabbt.
- Dra tummen eller ett finger långsamt över pekområdet om du vill bläddra igenom längdinställningarna långsamt.
- Tryck på den nedre eller övre delen av pekområdet om du vill gå igenom längdinställningarna en i taget. Om du vill bläddra igenom längdinställningarna automatiskt i steg om 0,1 mm håller du ned den nedre eller övre delen av pekområdet.



Minne:

Med minnet kan du spara tre längder per kam. Om du vill välja en sparad längd trycker du på M-knappen. Om du vill växla mellan minnesinställningar trycker du på M-knappen. Om du vill spara en längdinställning i minnet trycker du på M-knappen i två sekunder.



Längdlås:

Du kan bara ändra längdinställning när apparaten är avstängd.

TÜRKÇE



Uzunluk ayarları arasında geçiş yapmanın 3 yolu vardır:

- Uzunluk ayarları arasında hızlı bir şekilde geçiş yapmak için parmağınızı dokunmatik alanda hızlıca kaydırın.
- Uzunluk ayarları arasında yavaş bir şekilde geçiş yapmak için parmağınızı dokunmatik alanda yavaşça kaydırın.
- Uzunluk ayarları arasında teker teker geçiş yapmak için dokunmatik alanın alt veya üst kısmına dokununuz. Uzunluk ayarlarında 0,1 mm'lik adımlarla otomatik olarak geçiş yapmak için dokunmatik alanın alt veya üst kısmına dokununuz ve basılı tutunuz.



Hafıza:

Hafıza, tarak başına 3 uzunluk kaydetmenizi sağlar. Kaydedilmiş bir uzunluğu seçmek için 'M' düğmesine basın. Hafıza ayarları arasında geçiş yapmak için 'M' düğmesine basın. Bir uzunluk ayarını hafızaya kaydetmek için 'M' düğmesine 2 saniye boyunca basın.



Uzunluk kilidi:

Uzunluk ayarını yalnızca cihaz kapalıyken değiştirebilirsiniz.

فارسی

۳ روش برای تنظیم کردن وضعیت طول وجود دارد:

- شست یا انگشت خود را به سرعت حرکت دهید تا محل را لمس کرده و در تنظیمات طول به سرعت حرکت کنید.
- شست یا انگشت خود را به آرامی حرکت دهید تا محل را لمس کرده و در تنظیمات طول به آرامی حرکت کنید.
- روی بخش انتها یا بالای منطقه با انگشت ضربه بزنید تا یک به یک تنظیمات طول را کنید. برای حرکت در تنظیمات طول به طور اتوماتیک در گامهای ۰,۱ میلی متر، مشاهده انتخاب یا بالای منطقه لمس را ضربه کنید و تکه دارید.

حافظه:

حافظه به شما امکان می دهد ۳ تنظیم در هر شانه را ذخیره کنید. برای انتخاب تنظیم ذخیره شده، دکمه "M" را به مدت ۲ ثانیه فشار دهید. برای تغییر وضعیت حالت حافظه دکمه "M" را فشار دهید. برای انتخاب تنظیم ذخیره شده، دکمه "M" را به مدت ۲ ثانیه فشار دهید.

قفل طول:

فقط در صورتی که دستگاه خاموش باشد می توانید حالت قفل را تغییر دهید.



ثمة ثلاث طرق لاستعراض إعدادات الطول:

- اضغط بسرعة بالإبهام أو أحد الأصابع على منطقة اللمس للتمرير خلال إعدادات الطول بسرعة.
- اضغط ببطء بالإبهام أو أحد الأصابع على منطقة اللمس للتمرير خلال إعدادات الطول بطريقة بطيئة.
- اضغط على الجزء السفلي أو العلوي من منطقة اللمس لاستعراض إعدادات الطول واحد تلو الآخر. للتمرير خلال إعدادات الطول تلقائيًا بصورة تدريجية بواقع ١، مم، اضغط باستمرار على الجزء السفلي أو العلوي من منطقة اللمس.

**الذاكرة:**

- تسمح الذاكرة لك بحفظ ٣ أطوال لكل مشط. لاختيار طول محفوظ في الذاكرة، اضغط على زر 'M' لمدة ثانيتين. للتبديل بين إعدادات الذاكرة، اضغط على زر 'M'. لحفظ إعداد الطول في الذاكرة، اضغط على زر 'M' لمدة ثانيتين.

**قفل الطول:**

- يمكنك فقط تغيير إعداد الطول شريطة إيقاف تشغيل الجهاز.

