



One

















Instructions d'utilisation















Consignes de sécurité

-  Avant d'utiliser l'appareil pour la première fois, il faut lire attentivement l'intégralité du manuel d'instructions. Conserver les instructions à des fins d'utilisation ultérieure.
- 

Avertissements!

-  Ne pas utiliser l'appareil sans sac à poussière et sans filtre.
-  Cet appareil n'est pas destiné à l'aspiration de matériaux dangereux ou de gaz. Une telle utilisation comporte des risques graves pour la santé des personnes.
-  L'appareil ne doit pas être utilisé pour aspirer de l'eau et d'autres liquides.
-  Ne pas aspirer d'objets tranchants tels que des aiguilles ou des morceaux de verre.
-  Ne pas aspirer d'éléments en combustion ou dégagant de la fumée tels que des cigarettes, des allumettes ou des cendres chaudes.
-  Utiliser et entreposer l'appareil à l'intérieur, dans un endroit sec où la température est comprise entre 0 °C et 60 °C.
-  Ne pas utiliser l'appareil à l'extérieur.
-  Lors de l'activation du dispositif d'enroulement automatique du câble, faire attention à la fiche de l'extrémité du câble électrique en fin d'enroulement, car elle peut balancer. Il est recommandé de tenir la fiche pendant l'enroulement.
-  Ne pas manipuler l'appareil avec des mains mouillées.
-  Arrêter l'appareil avant de le débrancher.
-  Débrancher l'appareil en tenant la fiche et en ne tirant pas sur le câble d'alimentation. Ne pas porter ou traîner l'appareil par le câble d'alimentation.
-  L'appareil ne doit pas être utilisé s'il présente des signes de dommage. Inspecter régulièrement le câble à la recherche de dommage, en particulier s'il a été écrasé, coincé dans une porte ou aplati.
-  Ne pas utiliser l'appareil s'il semble défectueux. Faire contrôler l'appareil par un centre de service agréé s'il est tombé, a été endommagé, abandonné à l'extérieur ou exposé à l'eau.
-  Les dispositifs mécaniques et électriques de sécurité ne doivent pas être changés ou modifiés.
-  Toutes les réparations doivent être effectuées par un centre de service agréé.
-  Utiliser uniquement des sacs à poussière, filtres et accessoires d'origine fournis par le revendeur local. L'utilisation de sacs à poussière et de filtres non agréés annule la garantie.

-  Arrêter l'appareil et le débrancher avant de remplacer le sac à poussière ou un filtre. Débrancher l'appareil en tenant la fiche et en ne tirant pas sur le câble d'alimentation.
-  Si le câble d'alimentation est endommagé, il doit être remplacé par le fabricant, son agent technique ou une personne qualifiée afin d'éliminer tout danger.
-  Ne pas toucher les pièces en mouvement de la main lors de l'utilisation de la buse turbo.
-  L'appareil peut être utilisé par des enfants de 8 ans et plus et par des personnes à capacités physiques, sensorielles ou mentales réduites, ou manquant d'expérience et de connaissances, s'ils sont surveillés ou s'ils ont été formés à l'utilisation de l'aspirateur en toute sécurité et s'ils comprennent les risques encourus.
-  Il ne faut pas confier le nettoyage et la maintenance utilisateur à des enfants sans surveillance.
-  Les enfants doivent être surveillés pour être certain qu'ils ne jouent pas avec l'appareil.
-  Ne pas charger des piles non rechargeables.
-  Enlever les piles rechargeables de l'appareil avant de les charger.
-  Ne pas mélanger différents types de piles ou des piles neuves et usagées.
-  Respecter la polarité correcte lors de la mise en place des piles.
-  Retirer les piles usagées de l'appareil et les mettre au rebut en toute sécurité.
-  Si l'appareil doit être entreposé sans être utilisé pendant une longue période, retirer les piles.
-  Ne pas court-circuiter les bornes d'alimentation.

Entretien et maintenance

- Entreposer l'appareil à l'intérieur dans un endroit sec.
- Remplacer le préfiltre à chaque quatrième changement de sac à poussière.
 - Nettoyer la surface de l'appareil avec un chiffon sec ou humidifié avec un peu de produit nettoyant.
 - Commander des accessoires d'origine auprès d'un revendeur local.
 - Pour tout service, contacter votre revendeur local.

Responsabilité

Nilfisk réfute toute responsabilité pour les dommages causés par une utilisation incorrecte ou des modifications de l'appareil. Pour obtenir d'autres d'instructions ou des informations d'utilisation, visitez notre site Web à l'adresse www.nilfisk.com.

WEEE

Le symbole  indique que cet appareil ne peut pas être mis au rebut avec les ordures ménagères, mais doit être collecté séparément. Les appareils usagés doivent être remis au point de collecte approprié à des fins de recyclage.

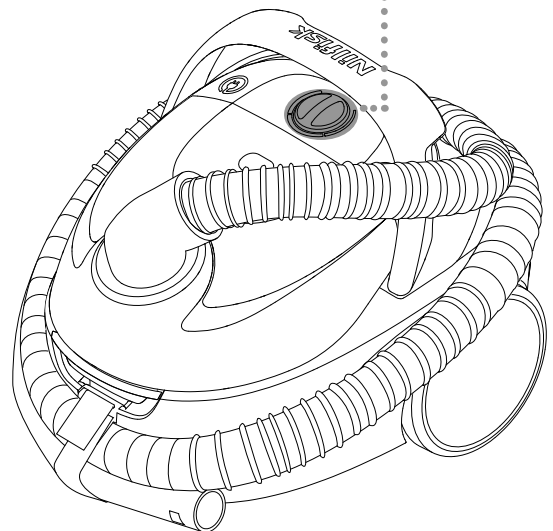
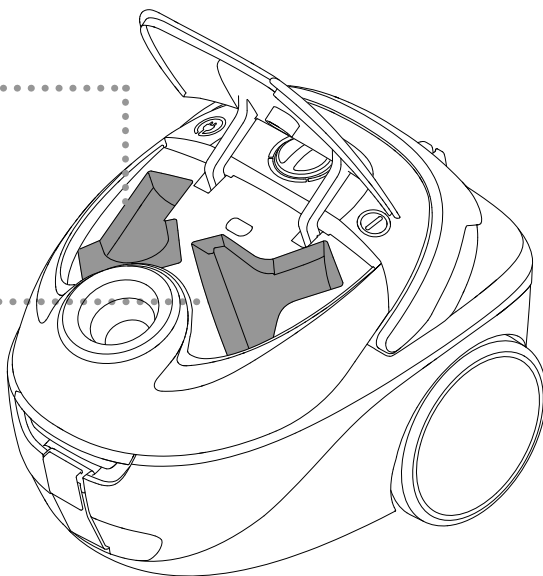
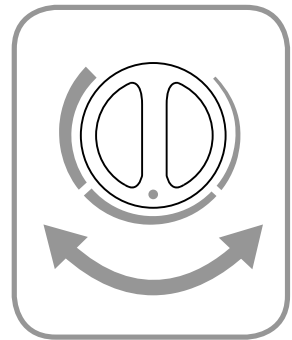
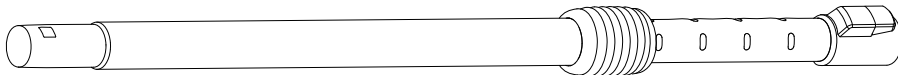
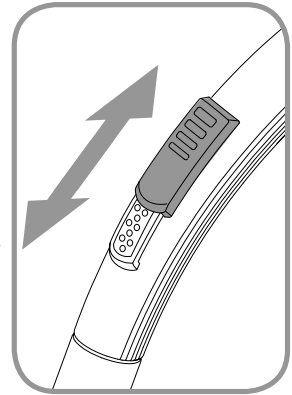
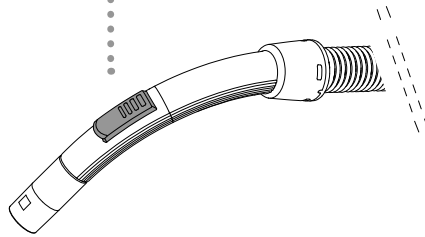
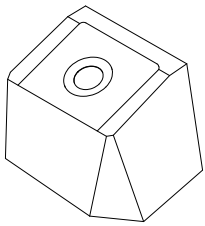
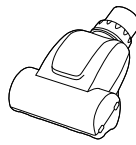
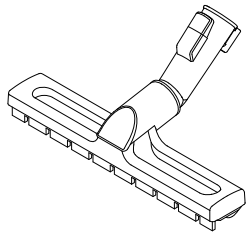
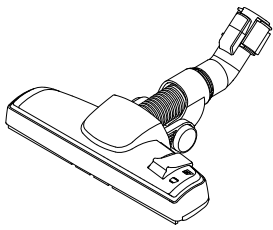

Les embouts proposés peuvent varier d'un modèle à l'autre.

A 

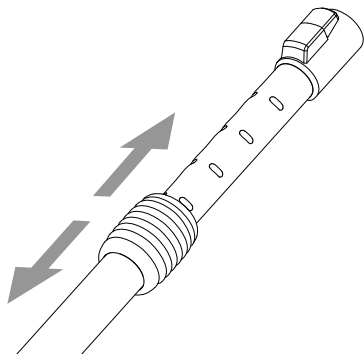
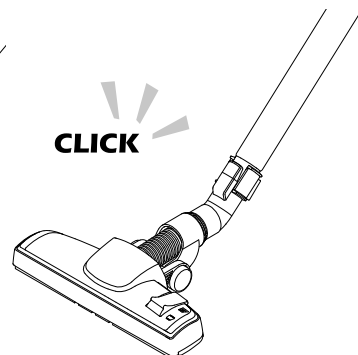
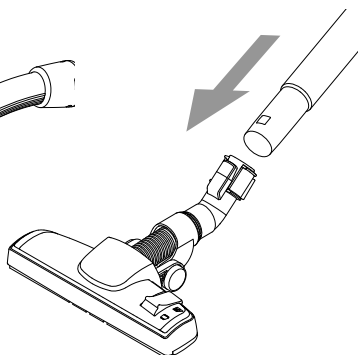
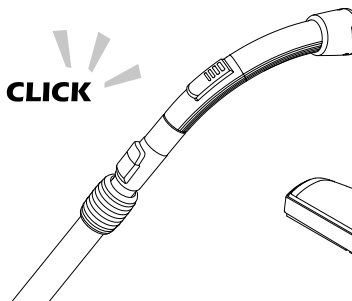
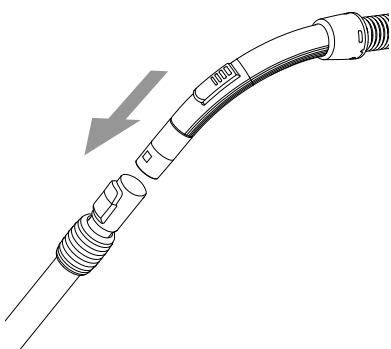
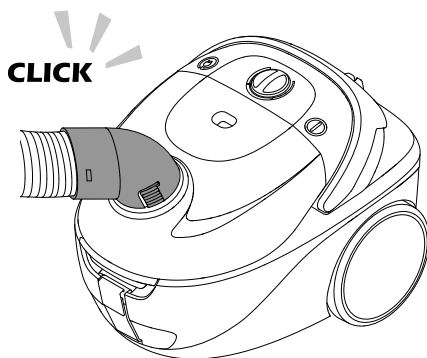
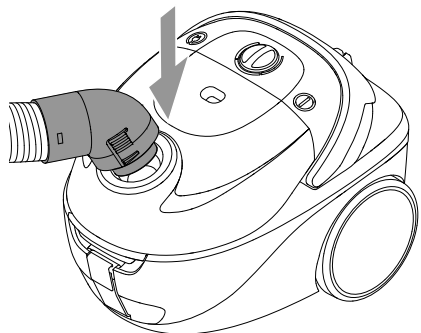

B 

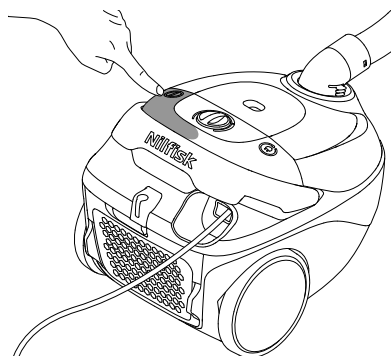
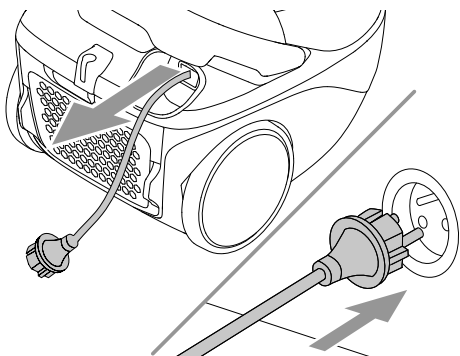

C 

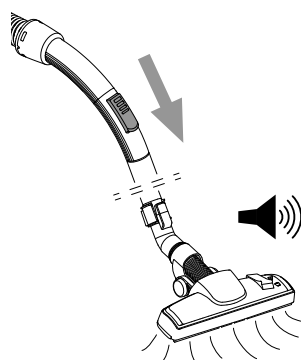
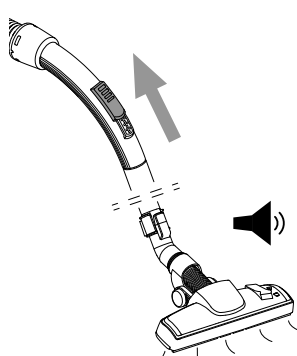
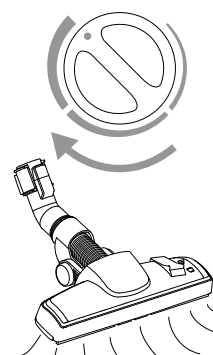
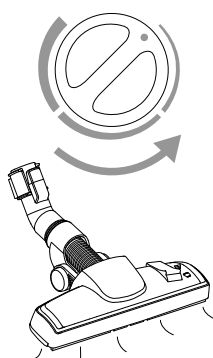
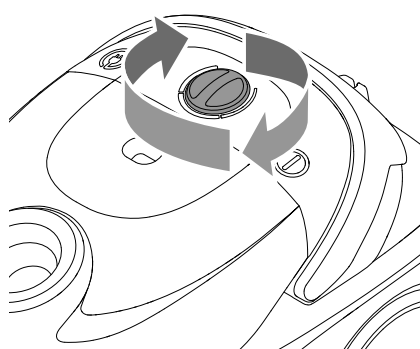

D 

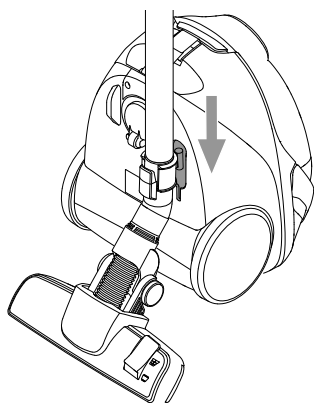
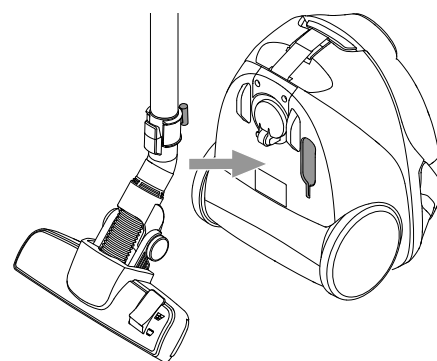
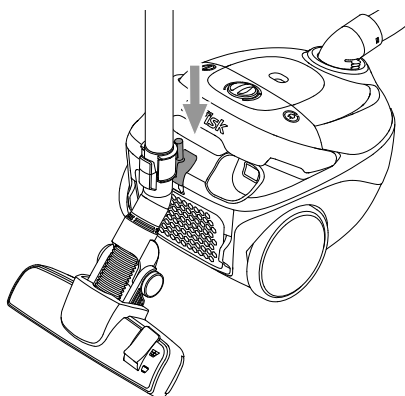
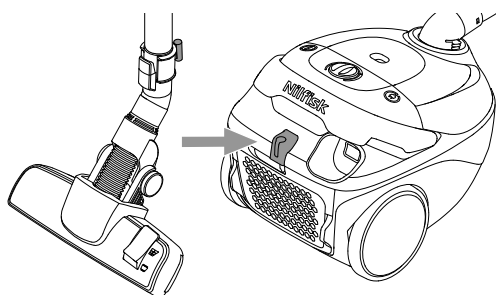

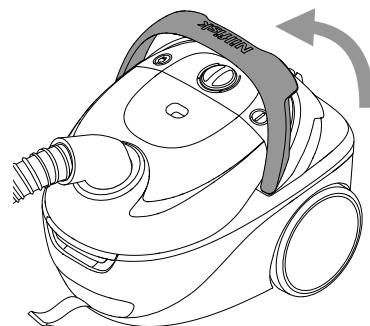
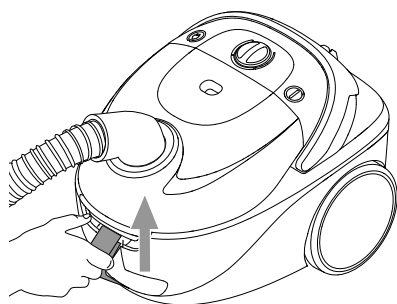
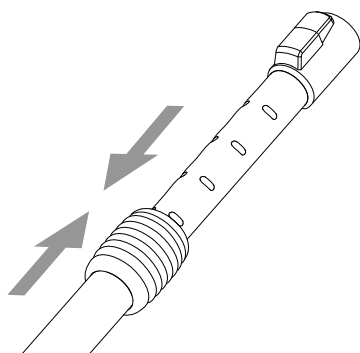
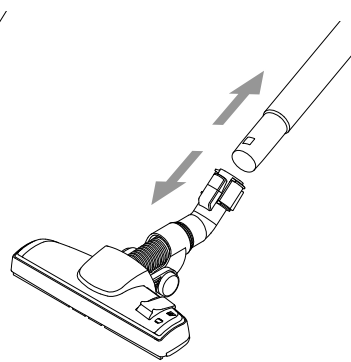
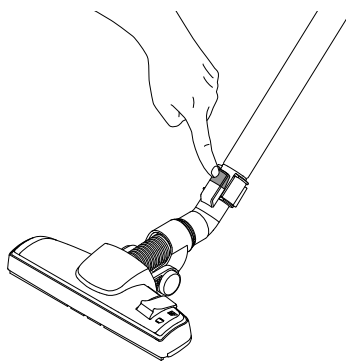
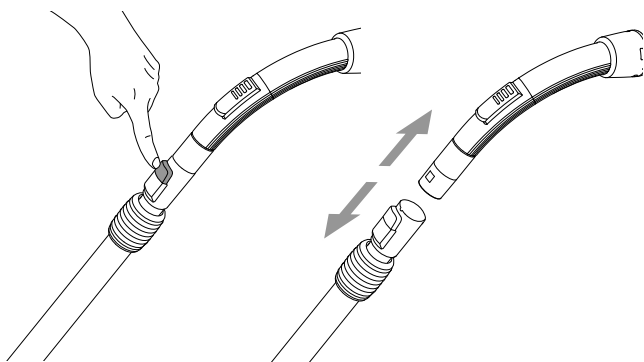
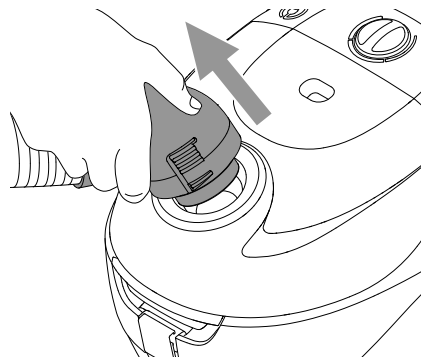
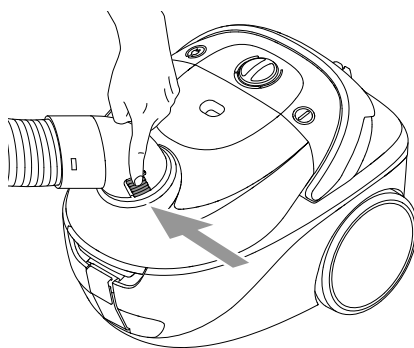
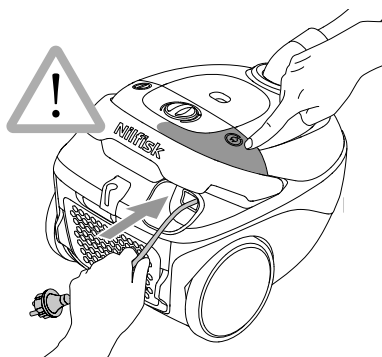
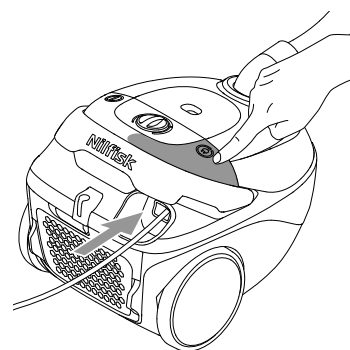
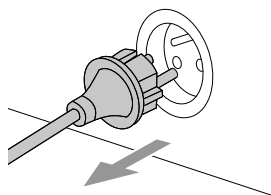
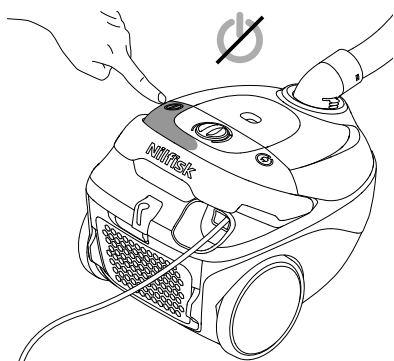

E

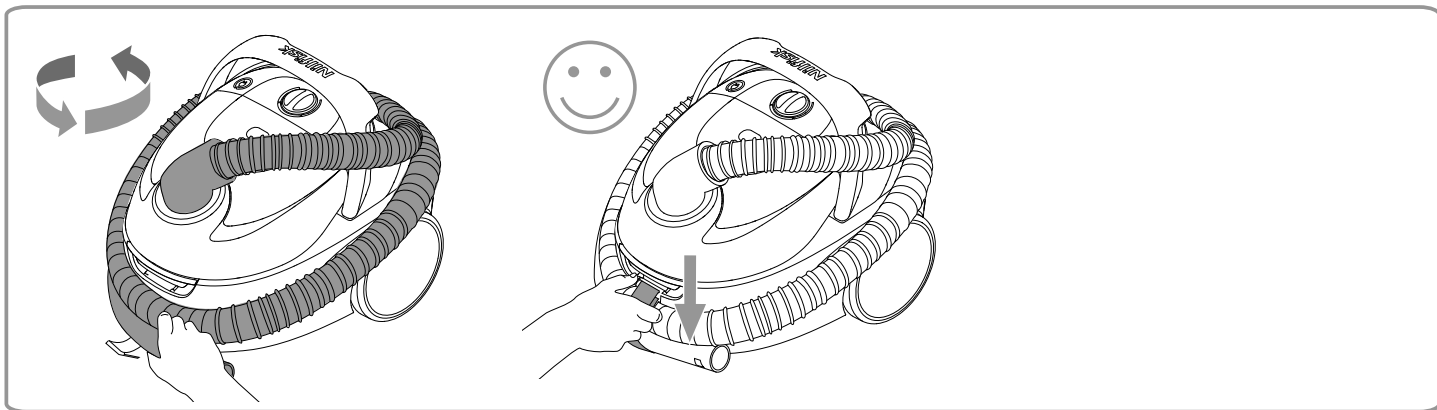

F

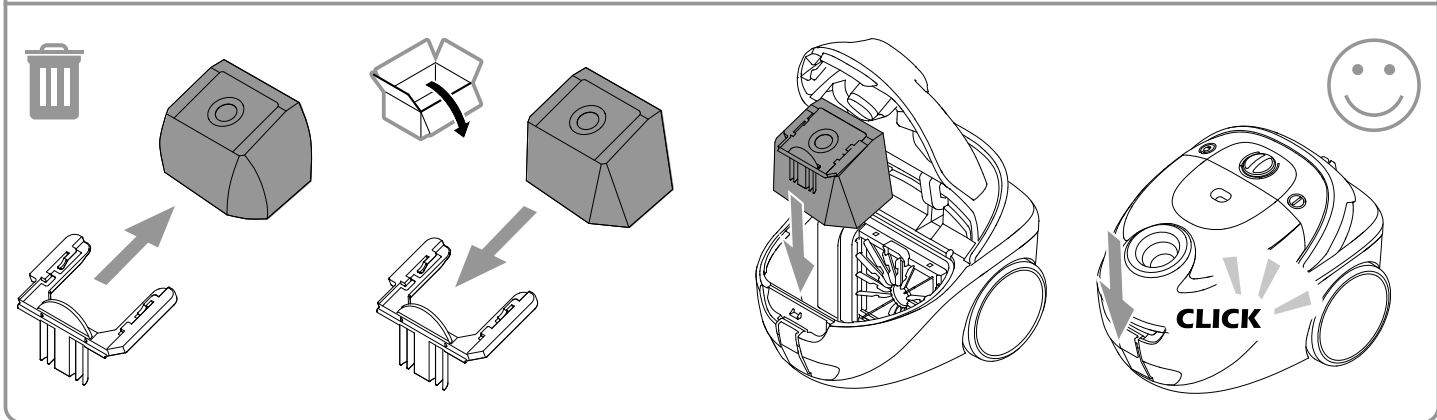
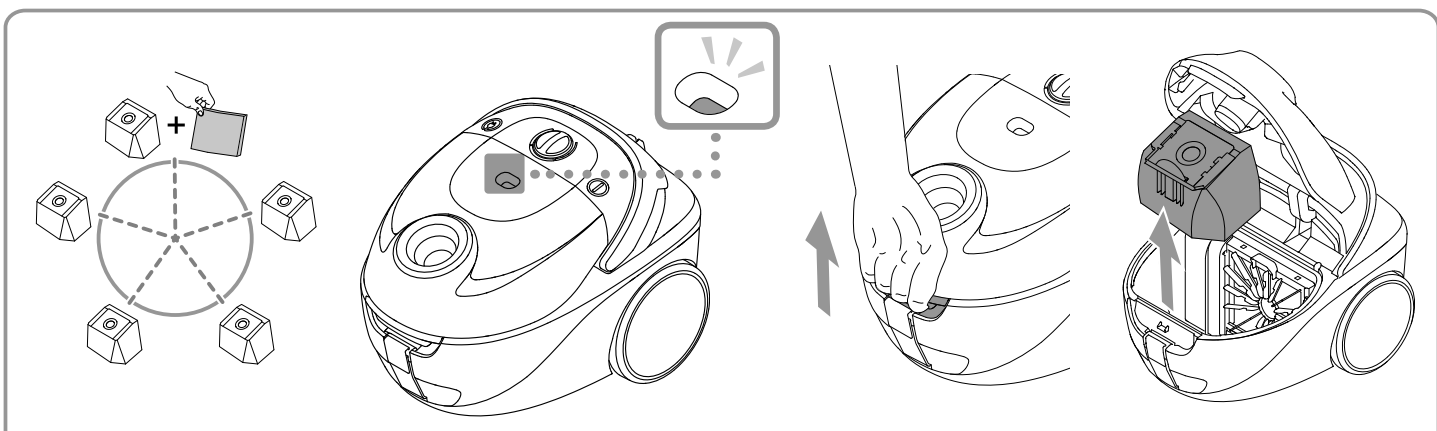

G

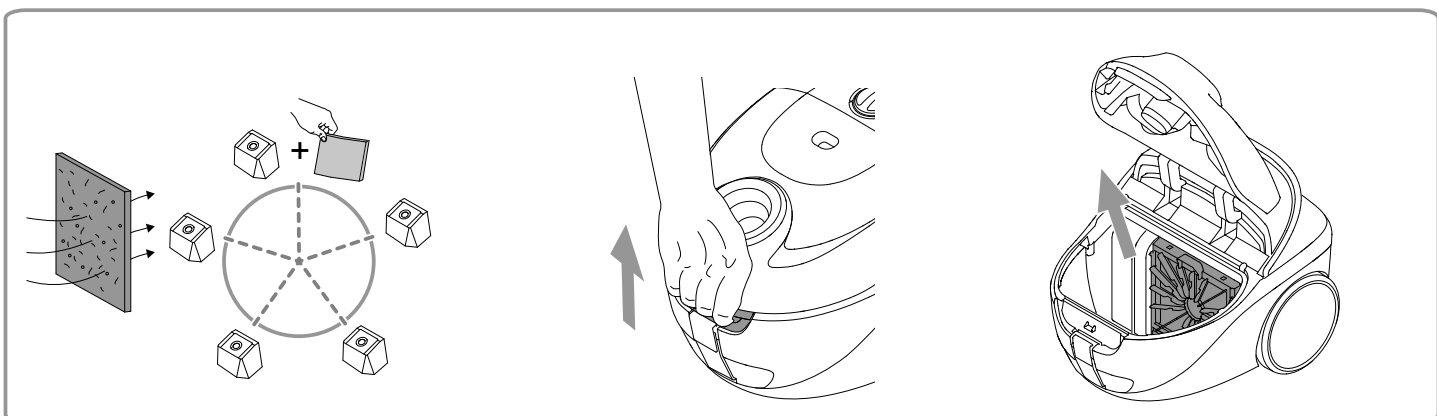

G

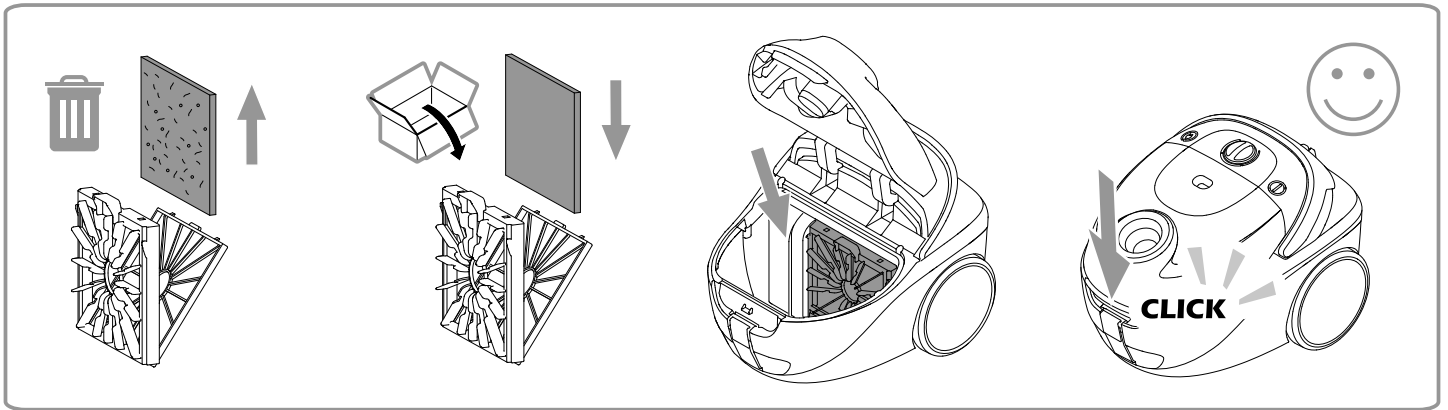

H

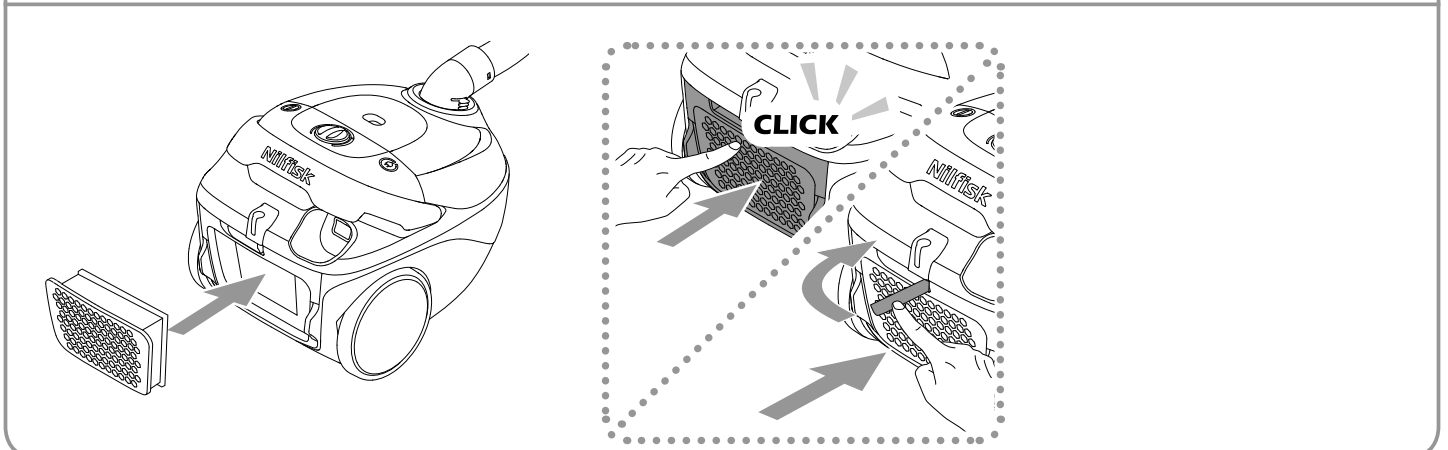
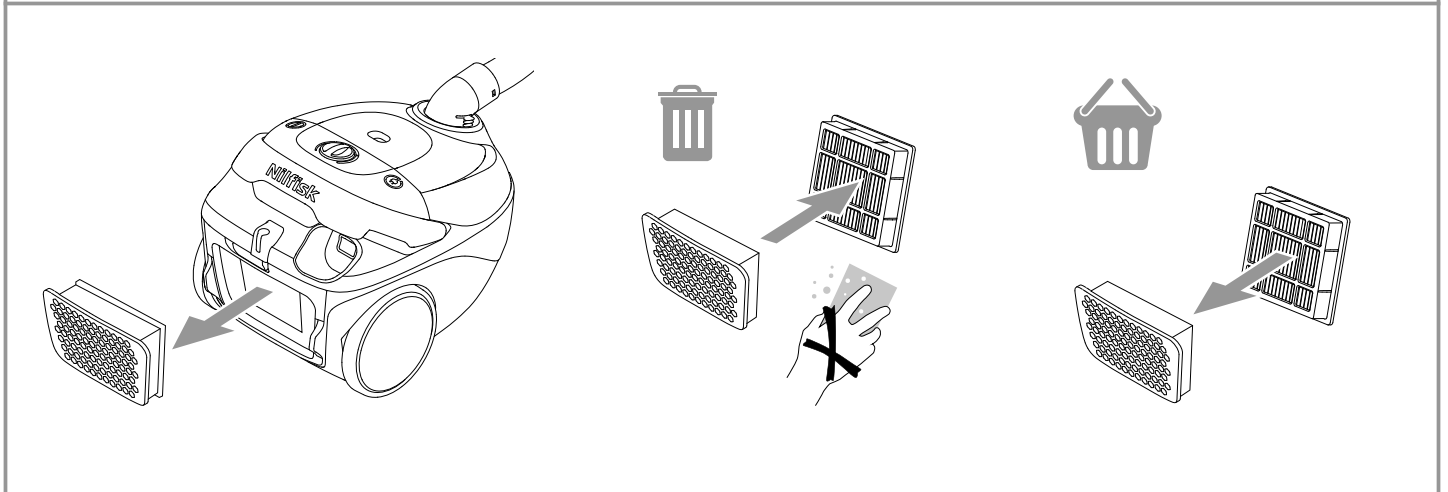
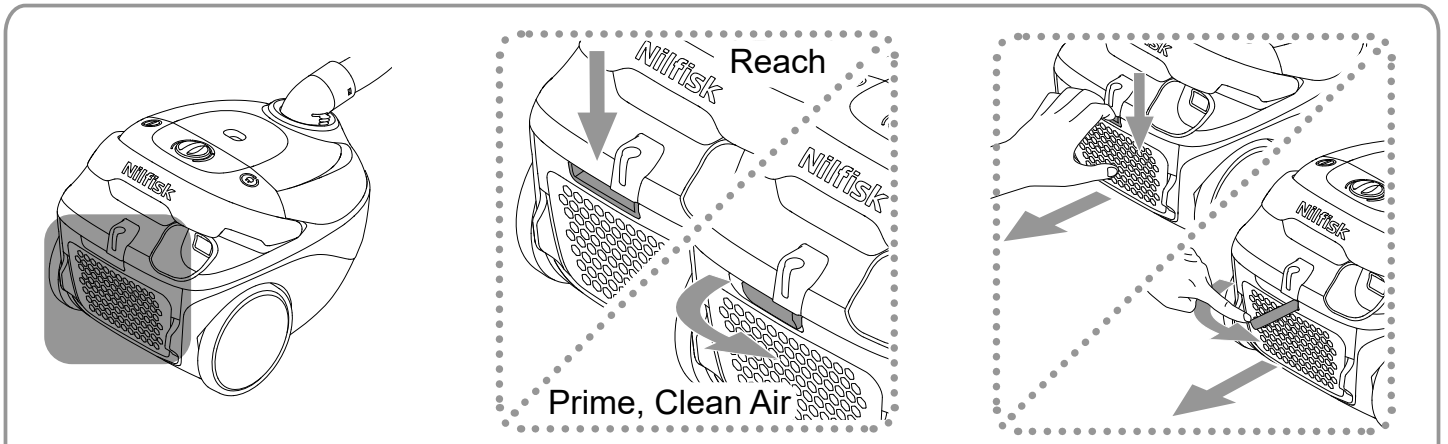

I 

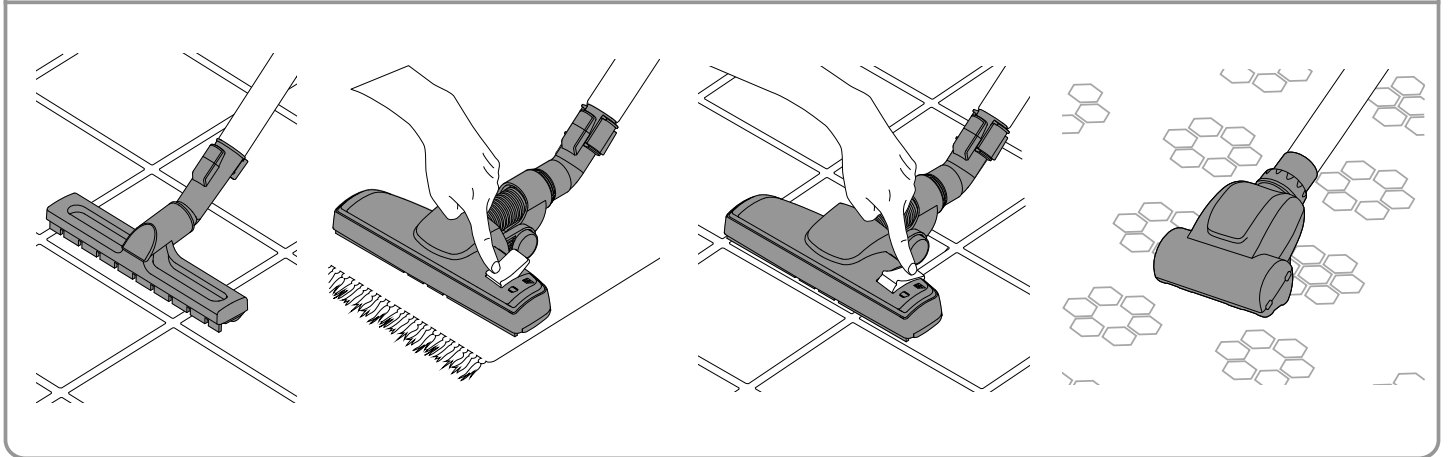
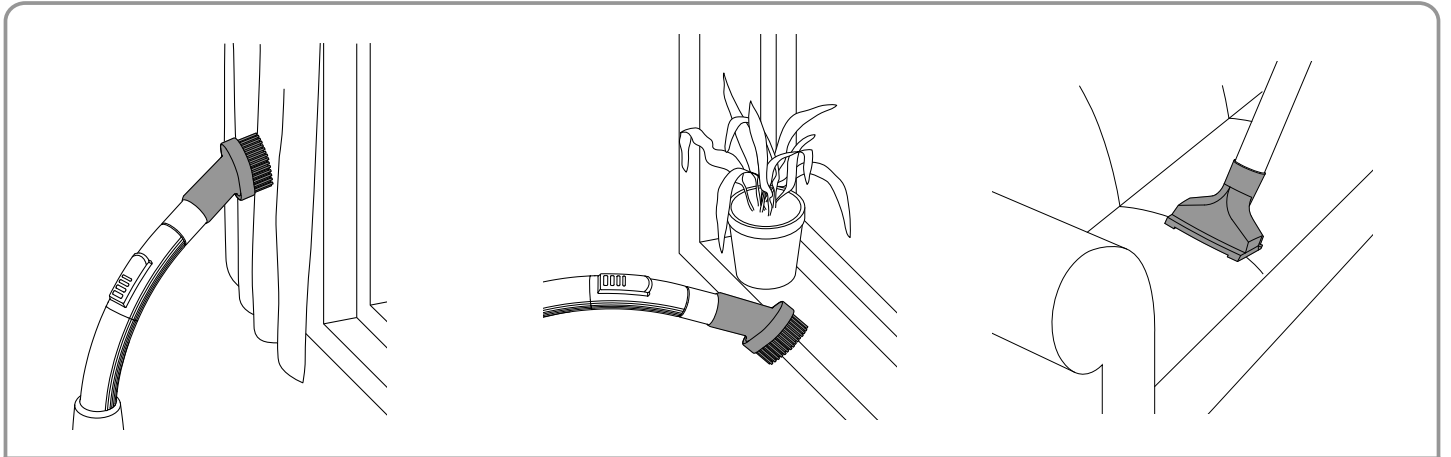

J 

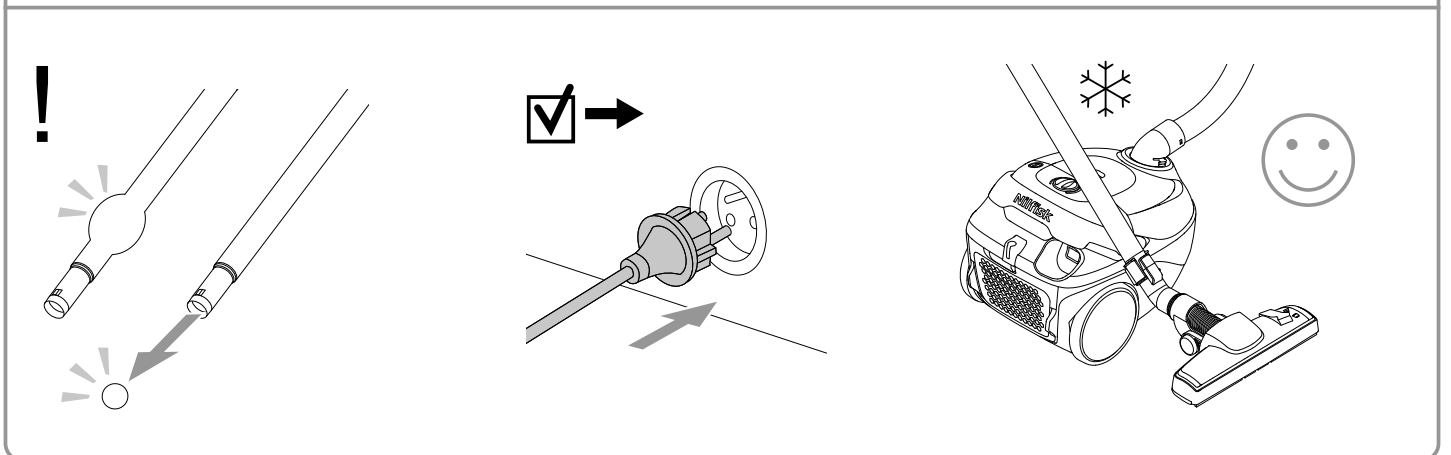
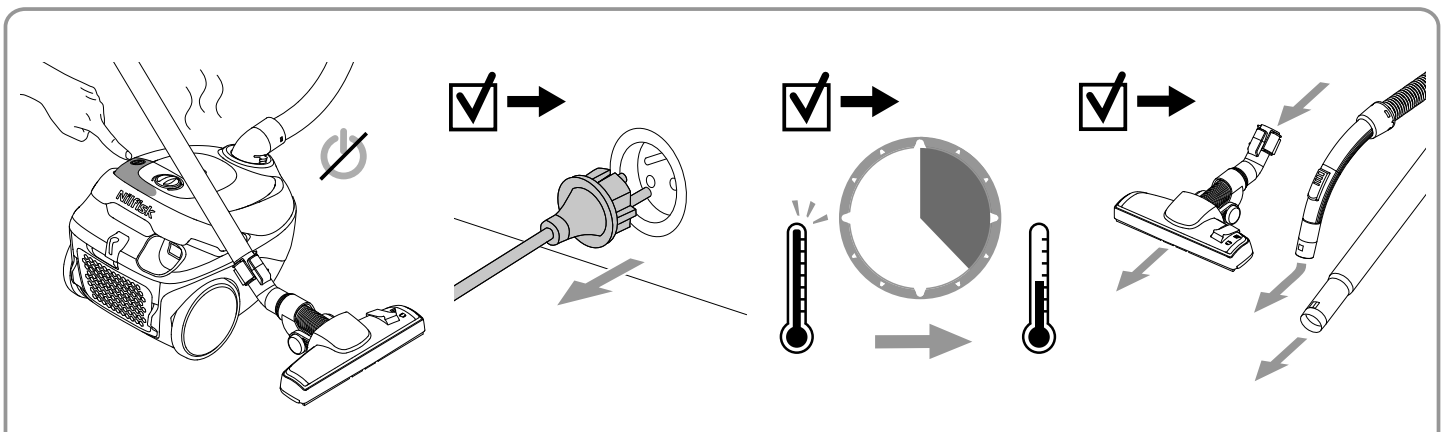

K

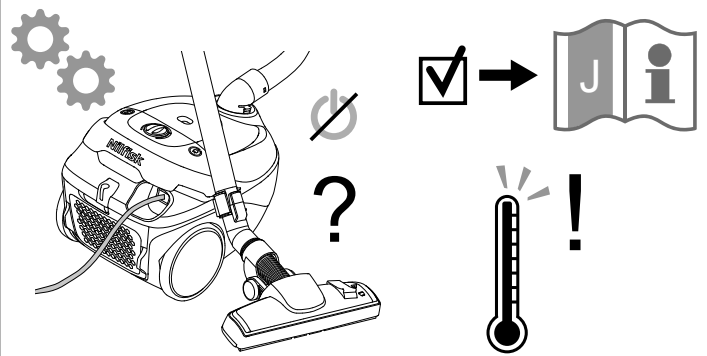
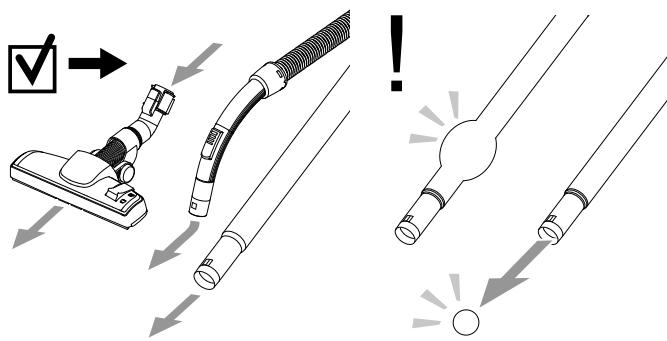
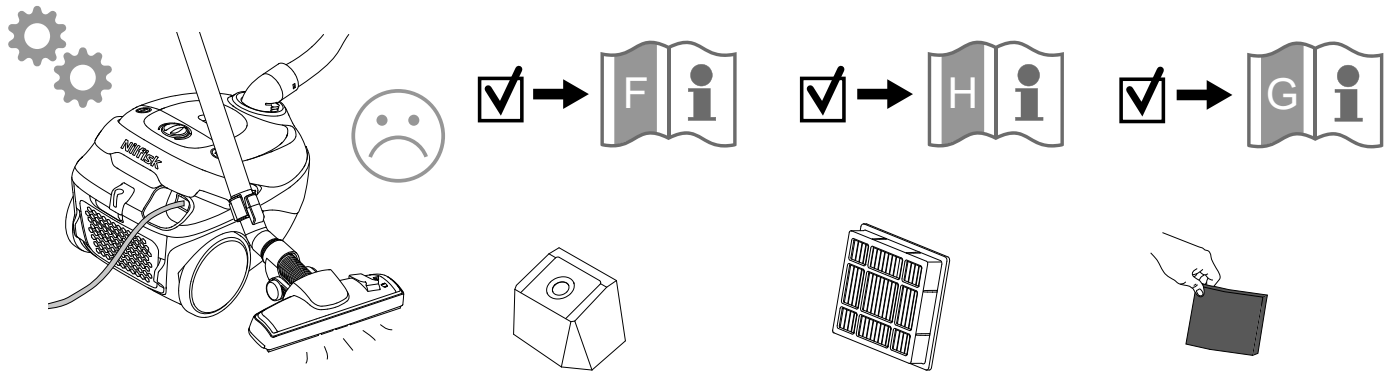

L

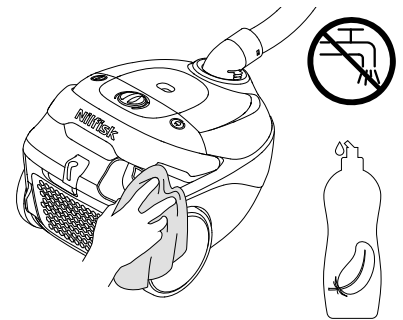
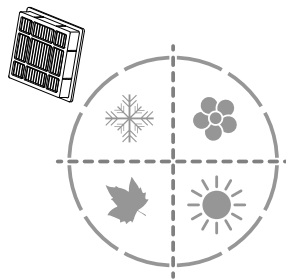
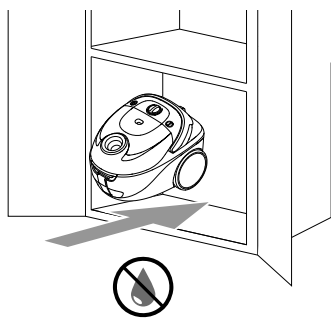



EU / UE / EL / EC / EE / ES / EÚ / AB

Declaration of Conformity

Prohlášení o shodě
Konformitätserklärung
Overensstemmelseserklæring
Declaración de conformidad
Vastavusdeklaratsioon
Déclaration de conformité
Vaatimustenmukaisuusvakuutus

Декларация за съответствие
Δήλωση συμμόρφωσης
Megfelelősségi nyilatkozat
Izjava o skladnosti
Dichiarazione di conformità
Atitikties deklaracija
Atbilstības deklarācija
Samsvarserklæring
Conformiteitsverklaring

Declaração de conformidade
Declaracja zgodności
Declaratie de conformitate
Декларация о соответствии
Försäkran om överensstämmelse
Vyhlasenie o zhode
Izjava o skladnosti
Uygunluk beyanı

Manufacturer / Výrobce / Hersteller / Fabrikant / Fabricante / Κατασκευαστής /
Gyártó / Proizvođač / Fabbicante / Gamintojas / Ražotājs / Produzent / Fabrikant /
Fabricante / Producent / Producător / производитель / Tillverkaren / Výrobca /
Proizvajalec / Üretici firma:

**Nilfisk A/S, Kornmarksvej 1
DK-2605 Broendby, DENMARK**

Product / Produkt / Producto, Toode, Produit, Tuote / Продукт /
Προϊόν / Termék / Proizvod / Prodotto / Produktas / Produkts /
Artikel / Produtos / Prods / Izdelek / Ürün

**One Performance Basic*, One Energy Basic*, One
Performance Prime*, where * means Country
Code**

Description / Popis / Beschreibung / Beskrivelse / Descripción /
Kirjeldus / La description / Kuvaus / Описание / Περιγραφή / Leirás /
Opis / Descrizione / Aprašymas / Apraksts / Beschrijving / Descrição /
Descriere / Beskrivning / Popis / Açıklama

**VAC - Consumer - Dry
220-240V 50-60Hz, IPX0**

- | | | |
|---|---|---|
| EN We, Nilfisk hereby declare under our sole responsibility, that the above-mentioned product(s) is/are in conformity with the following directives and standards. | BG Ние, Nilfisk С настоящото декларираме на своя лична отговорност, че посочените по-горе продуктът е в съответствие със следните директиви и стандарти. | PT Nós, a Nilfisk declaramos, sob nossa exclusiva responsabilidade, que o produto acima mencionado está em conformidade com as diretrizes e normas a seguir. |
| CS My, Nilfisk prohlašujeme na svou výlučnou odpovědnost, že výše uvedený výrobek je ve shodě s následujícími směrnici a normami. | EL Εμείς, Nilfisk δηλώνουμε με αποκλειστική μας ευθύνη, ότι το προαναφερόμενο προϊόν συμμορφώνεται με τις ακόλουθες οδηγίες και πρότυπα. | PL My, Nilfisk Niniejszym oświadczamy z pełną odpowiedzialnością, że wyżej wymieniony produkt jest zgodny z następującymi dyrektywami i normami.. |
| DE Wir, Nilfisk erklären in alleiniger Verantwortung, dass das oben genannte Produkt den folgenden Richtlinien und Normen entspricht. | HU Mi, Nilfisk kijelentjük, egyedüli felelősséggel, hogy a fent említett termék megfelel az alábbi irányelveknek és szabványoknak | RO Noi, Nilfisk Prin prezenta declarăm pe propria răspundere, că produsul mai sus menționat este în conformitate cu următoarele standarde și directive. |
| DA Vi, Nilfisk erklærer hermed under eget ansvar at ovennævnte produkt(er) er i overensstemmelse med følgende direktiver og standarder. | HR Mi, Nilfisk izjavljujemo pod punom odgovornošću, da gore navedeni proizvod u skladu sa sljedećim direktivama i standardima. | RU Мы, Nilfisk настоящим заявляем под нашу полную ответственность, что вышеперечисленные продукция соответствует следующими директивам и стандартам. |
| ES Nosotros, Nilfisk declaramos bajo nuestra única responsabilidad que el producto antes mencionado está en conformidad con las siguientes directivas y normas | IT Noi, Nilfisk dichiara sotto la propria responsabilità, che il prodotto di cui sopra è conforme alle seguenti direttive e norme. | SV Vi Nilfisk förklarar härmed under eget ansvar att ovan nämnda produkt överensstämmer med följande direktiv och normer. |
| ET Meie, Nilfisk Käesolevaga kinnitame ja kanname ainusikulist vastutust, et eespool nimetatud toode on kooskõlas järgmiste direktiivide ja | LT Mes, "Nilfisk pareiškiu vienašališkos atsakomybės, kad pirmiau minėtas produkts atitinka šias direktyvas ir standartus | SK My, Nilfisk prehlasujeme na svoju výlučnú zodpovednosť, že vyššie uvedený výrobok je v zhode s nasledujúcimi smernicami a normami. |
| FR Nilfisk déclare sous notre seule responsabilité que le produit mentionné ci-dessus est conforme aux directives et normes suivantes. | LV Mēs, Nilfisk šo apliecinu ar pilnu atbildību, ka iepriekš minētais produkts atbilst šādām direktīvām un standartiem | SL Mi, Nilfisk izjavljamo s polno odgovornostjo, da je zgoraj omenjeni izdelek v skladu z naslednjimi smernicami in standardi. |
| FI Me, Nilfisk täten vakuutamme omalla vastuulla, että edellä mainittu tuote on yhdenmukainen seuraavien direktiivien ja standardien mukaisesti | NO Vi, Nilfisk erklærer herved under eget ansvar, at det ovennevnte produktet er i samsvar med følgende direktiver og standarder | TR Nilfisk, burada yer alan tüm sorumluluklarımızı göze, yukarıda belirtilen ürünün aşağıdaki direktifler ve standartlara uygun olduğunu beyan ederiz. |
| NL We verklaren Nilfisk hierbij op eigen verantwoordelijkheid, dat het bovengenoemde product voldoet aan de volgende richtlijnen en normen | | |

2014/35/EU	EN 60335-1:2012+A11:2014+A13:2017+A1:2019+A2:2019+A14:2019 EN 60335-2-2:2010+A11:2012+A1:2013
2014/30/EU	EN 55014-1:2017 EN 55014-2:2015 EN 61000-3-2:2014 EN 61000-3-3:2013
2011/65/EU	EN 50581:2012
2009/125/EC 666/2013/EU	EN 60312-1:2017 EN 60704-2-1:2015

Authorized signatory: Pierre Mikaelsson, Executive Vice President, Global Products & Services, Nilfisk NLT

May 11, 2020



HEAD QUARTER

DENMARK

Nilfisk A/S
Kornmarksvej 1
DK-2605 Broendby
Tel.: (+45) 4323 8100
Website: www.nilfisk.com

SALES COMPANIES

ARGENTINA

Nilfisk srl.
Edificio Central Park
Herrera 1855, 6th floor/604
Ciudad de Buenos Aires
Tel.: (+54) 11 6091 1571
Website: www.consumer.nilfisk.com.ar

AUSTRALIA

Nilfisk Pty Ltd
Unit 1/13 Bessemer Street
Blacktown NSW 2148
Tel.: (+61) 2 98348100
Website: www.consumer.nilfisk.com.au

AUSTRIA

Nilfisk GmbH
Metzgerstrasse 68
5101 Bergheim bei Salzburg
Tel.: (+43) 662 456 400 90
Website: www.nilfisk.at

BELGIUM

Nilfisk n.v.s.a.
Riverside Business Park
Boulevard Internationaaleaan 55
Bâtiment C3/C4 Gebouw
Bruxelles 1070
Tel.: (+32) 24 67 60 50
Website: www.consumer.nilfisk.be

Brazil

Nilfisk do Brasil
Av. Eng. Luis Carlos Berrini, 550
40 Andar, Sala 03
SP - 04571-000 Sao Paulo
Tel.: (+11) 3959-0300 / 3945-4744
Website: www.nilfisk.com.br

CANADA

Nilfisk Canada Company
240 Superior Boulevard
Mississauga, Ontario L5T 2L2
Tel.: (+1) 800-668-8400
Website: www.nilfisk.ca

CHILE

Nilfisk S.A. (Comercial KCS Ltda)
Salar de Llamara 822
8320000 Santiago
Tel.: (+56) 2684 5000
Website: www.nilfisk.cl

CHINA

Nilfisk
4189 Yindu Road
Xinzhuang Industrial Park
201108 Shanghai
Tel.: (+86) 21 3323 2000
Website: www.nilfisk.cn

CZECH REPUBLIC

Nilfisk s.r.o.
VGP Park Horní Počernice
Do Čertous 1/2658
193 00 Praha 9
Tel.: (+420) 244 090 912
Website: www.consumer.nilfisk.cz

DENMARK

Nilfisk A/S
Kornmarksvej 1
2605 Broendby
Tel.: (+45) 4323 4050
Website: www.consumer.nilfisk.dk

FINLAND

Nilfisk Oy Ab
Koskelontie 23 E
02920 Espoo
Tel.: (+358) 207 890 600
Website: www.consumer.nilfisk.fi

FRANCE

Nilfisk SAS
26 Avenue de la Baltique
Villebon sur Yvette
91978 Courtaubouef Cedex
Tel.: (+33) 169 59 87 24
Website: www.consumer.nilfisk.fr

GERMANY

Nilfisk GmbH
Guido-Oberdorfer-Strasse 2-10
89287 Bellenberg
Tel.: (+49) (0)7306/72-444
Website: www.consumer.nilfisk.de

GREECE

Nilfisk A.E.
Αναπαύσεως 29
Κορωπί Τ.Κ. 194 00

Tel.: (30) 210 9119 600
Website: www.consumer.nilfisk.gr

HOLLAND

Nilfisk B.V.
Versterkerstraat 5
1322 AN Almere
Tel.: (+31) 036 5460760
Website: www.consumer.nilfisk.nl

HONG KONG

Nilfisk Ltd.
2001 HK Worsted Mills
Industrial Building
31-39, Wo Tong Tsui St.
Kwai Chung, N.T.
Tel.: (+852) 2427 5951
Website: www.nilfisk.com

HUNGARY

Nilfisk Kft.
II. Rákóczi Ferenc út 10
2310 Szigetszentmiklós-Lakihegy
Tel.: (+36) 24 475 550
Website: www.nilfisk.hu

INDIA

Nilfisk India Limited
Pramukh Plaza, 'B' Wing, 4th floor, Unit No. 403
Cardinal Gracious Road, Chakala
Andheri (East) Mumbai 400 099
Tel.: (+91) 22 6118 8188
Website: www.nilfisk.in

IRELAND

Nilfisk
1 Stokes Place
St. Stephen's Green
Dublin 2
Tel.: (+35) 3 12 94 38 38
Website: www.nilfisk.ie

ITALY

Nilfisk SpA
Strada Comunale della Braglia, 18
26862 Guardamiglio (LO)
Tel.: (+39) (0) 377 414021
Website: www.nilfisk.it

JAPAN

Nilfisk Inc.
1-6-6 Kita-shinyokohama, Kouhoku-ku
Yokohama, 223-0059
Tel.: (+81) 45548 2571
Website: www.nilfisk.com

MALAYSIA

Nilfisk Sdn Bhd
Sd 33, Jalan KIP 10
Taman Perindustrian KIP
Sri Damansara
52200 Kuala Lumpur
Tel.: +603 6275 3120
Website: www.nilfisk.com

MEXICO

Nilfisk de Mexico, S. de R.L. de C.V.
Pirneos #515 Int.
60-70 Microparque
Industrial WSantiago
76120 Queretaro
Tel.: (+52) (442) 427 77 00
Website: www.nilfisk.com

NEW ZEALAND

Nilfisk Limited
Suite F, Building E
42 Tawa Drive
0632 Albany Auckland
Tel.: (+64) 9 414 1996
Website: www.nilfisk.com

NORWAY

Nilfisk AS
Bjørnerudveien 24
1266 Oslo
Tel.: (+47) 22 75 17 80
Website: www.consumer.nilfisk.no

PERU

Nilfisk S.A.C.
Calle Boulevard 162, Of. 703, Lima 33- Peru
Lima
Tel.: (511) 435-6840
Website: www.nilfisk.com

POLAND

Nilfisk Sp. Z.O.O.
Millenium Logistic Park
ul. 3 Maja 8, Bud. B4
05-800 Pruszków
Tel.: (+48) 22 738 3750
Website: www.consumer.nilfisk.pl

PORTUGAL

Nilfisk Lda.
Sintra Business Park
Zona Industrial Da Abrunheira
Edifício 1, 1º A
P2710-089 Sintra
Tel.: (+351) 21 911 2670
Website: www.nilfisk.pt

RUSSIA

Nilfisk LLC

Vyatskaya str. 27, bld. 7/1st
127015 Moscow
Tel.: (+7) 495 783 9602
Website: www.consumer.nilfisk.ru

SINGAPORE

Den-Sin
22 Tuas Avenue 2
639453 Singapore
Tel.: (+65) 6268 1006
Website: www.densin.com

SLOVAKIA

Nilfisk s.r.o.
Bancíkovej 1/A
SK-821 03 Bratislava
Tel.: (+421) 910 222 928
Website: www.consumer.nilfisk.sk

SOUTH AFRICA

Nilfisk (Pty) Ltd
Kimbul Office Park, 9 Zeiss Road
Laser Park, Honeydew
Johannesburg
Tel.: (+27) 118014600
Website: www.nilfisk.co.za

SOUTH KOREA

Nilfisk Korea
3F Duksoo B/D. 317-15
Sungsoo-Dong 2Ga
Sungdong-Gu, Seoul
Tel.: (+82) 2497 8636
Website: www.nilfisk.co.kr

SPAIN

Nilfisk S.A.U
Paseo del Rengle, 5 Planta. 9-10
08302 Mataró
Tel.: (+34) 93 741 2400
Website: www.consumer.nilfisk.es

SWEDEN

Nilfisk AB
Taljegårdsgatan 4
431 53 Mölndal
Tel.: (+46) 31 706 73 00
Website: www.consumer.nilfisk.se

SWITZERLAND

Nilfisk AG
Ringstrasse 19
Kircheberg/Industri Stelz
9500 Wil
Tel.: (+41) 71 92 38 444
Website: www.consumer.nilfisk.ch

TAIWAN

Nilfisk Ltd
Taiwan Branch (H.K)
No. 5, Wan Fang Road
Taipei
Tel.: (+88) 6227 00 22 68
Website: www.nilfisk.tw

THAILAND

Nilfisk Co. Ltd.
89 Soi Chokechai-Ruammitr
Viphavadee-Rangsit Road
Ladyao, Jatuchak, Bangkok 10900
Tel.: (+66) 2275 5630
Website: www.nilfisk.co.th

TURKEY

Nilfisk A.S.
Serifali Mh. Bayraktar Bulv. Sehit Sk. No:7
Ümraniye, 34775 Istanbul
Tel.: +90 216 466 94 94
Website: www.consumer.nilfisk.com.tr

UNITED ARAB EMIRATES

Nilfisk Middle East Branch
SAIF-Zone
P.O. Box 122298
Sharjah
Tel.: (+971) (0) 655-78813
Website: www.nilfisk.com

UNITED KINGDOM

Nilfisk Ltd.
Nilfisk House, Bowerbank Way
Gilwilly Industrial Estate, Penrith
Cumbria CA11 9BQ
Tel.: (+44) (0) 1768 868995
Website: www.consumer.nilfisk.co.uk

UNITED STATES

Nilfisk Inc.
14600 21st Avenue North
Plymouth, MN-55447
Tel.: (+1) 800-989-2235
Website: www.nilfisk.com

VIETNAM

Nilfisk Vietnam
No. 51 Doc Ngu Str.
P. Vinh Phuc, Q.Ba Dinh
Hanoi
Tel.: (+84) 761 5642
Website: www.nilfisk.com

