

OLED55BX\*  
OLED65BX\*

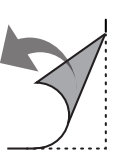

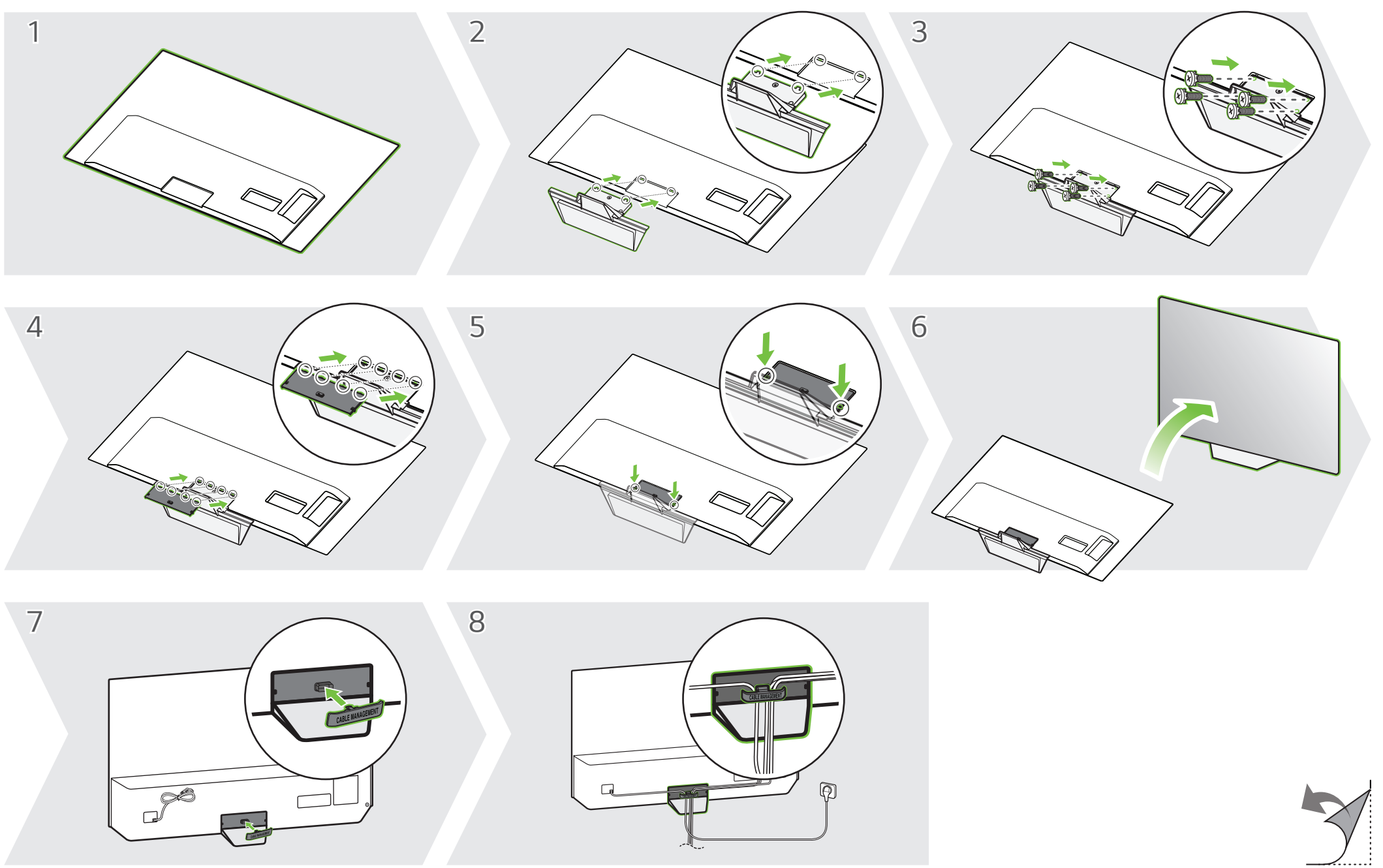

|  | A                         | B   | C   | D   | E    | F    | F-G  |
|--|---------------------------|-----|-----|-----|------|------|------|
|  | (mm)                      |     |     |     |      | (kg) |      |
| OLED55BX3LA<br>OLED55BX3LB<br>OLED55BX6LA<br>OLED55BX6LB<br>OLED55BX9LA<br>OLED55BX9LB<br>OLED55BXRLA<br>OLED55BXRLB | 1228                      | 744 | 246 | 706 | 46.9 | 19.9 | 18.9 |
| OLED65BX3LA<br>OLED65BX3LB<br>OLED65BX6LA<br>OLED65BX6LB<br>OLED65BX9LA<br>OLED65BX9LB<br>OLED65BXRLA<br>OLED65BXRLB | 1449                      | 869 | 246 | 830 | 46.9 | 25.0 | 24.0 |
| Power requirement  | AC 100-240 V ~ 50 / 60 Hz |     |     |     |      |      |      |

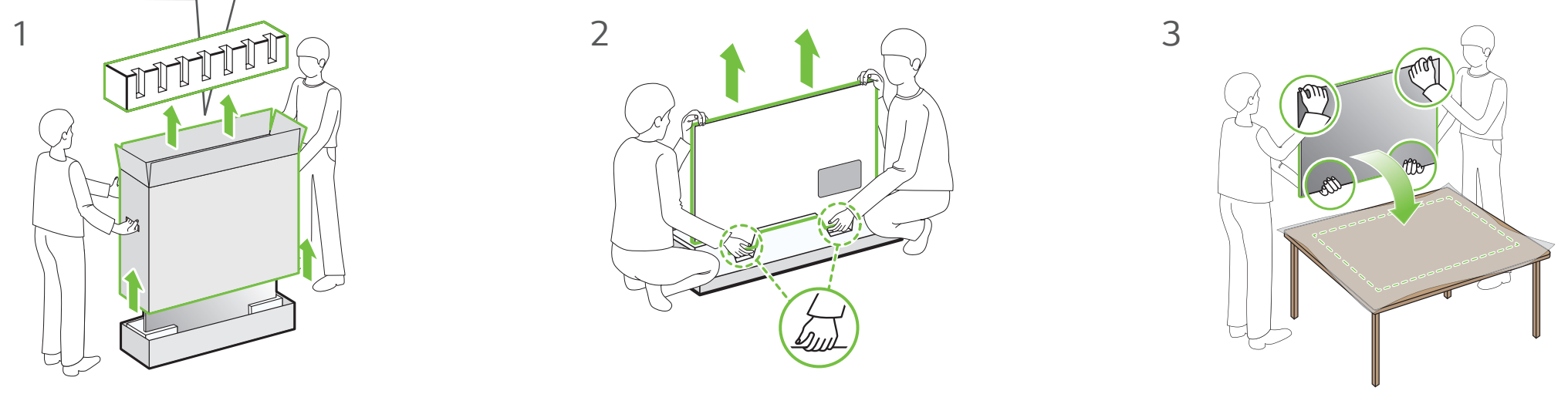
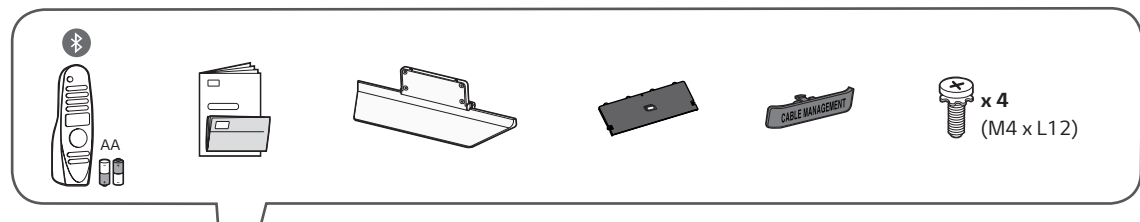
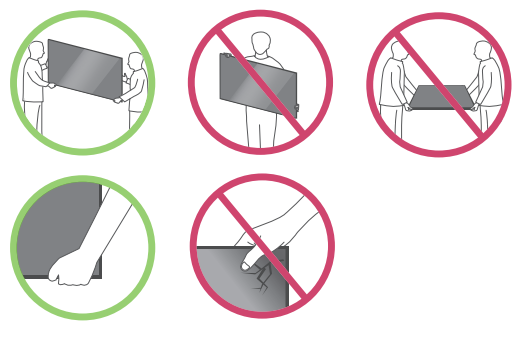
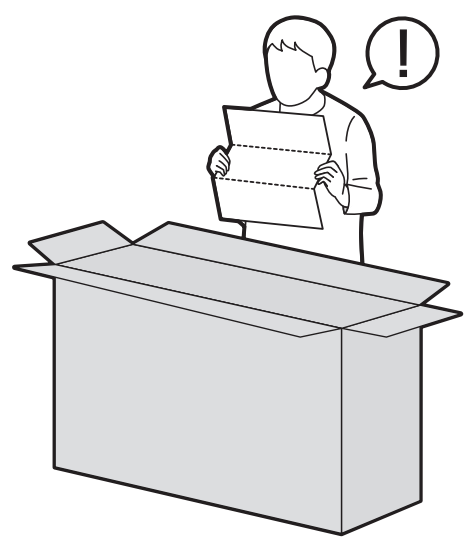
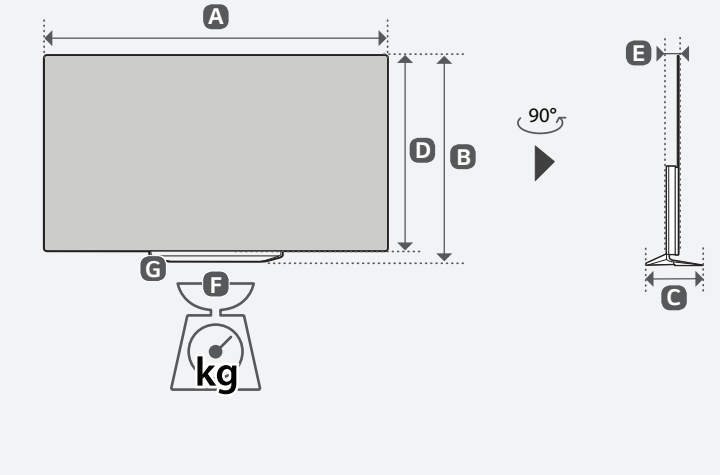
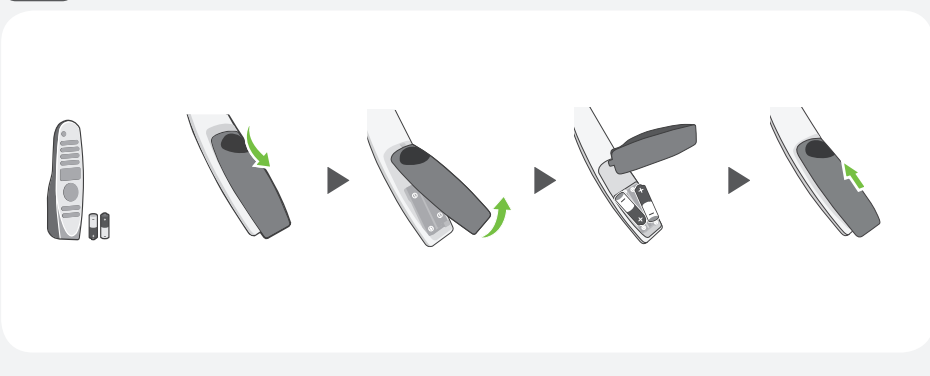
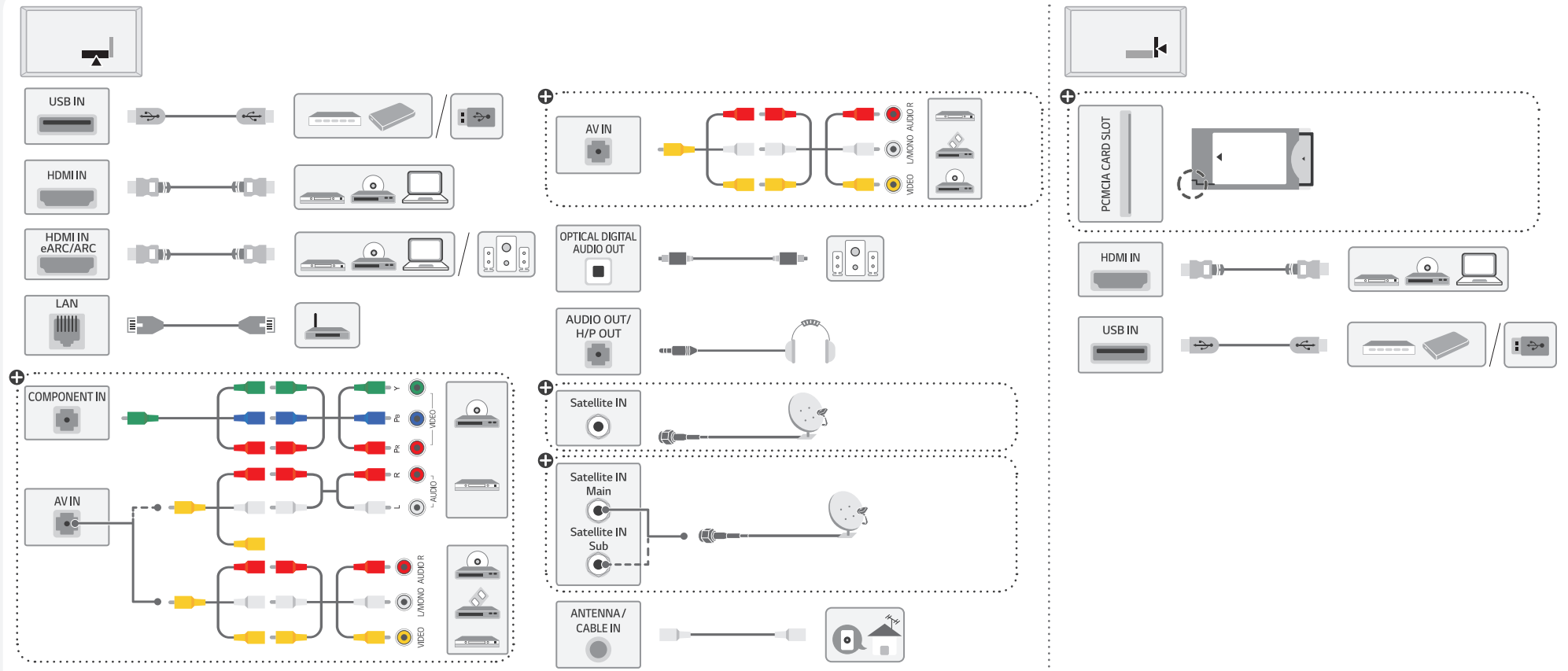

|             |  |            |  |             |  |
|-------------|--|------------|--|-------------|--|
| English     | · Read Safety and Regulatory.  | Hrvatski   | · Pročitajte <b>Sigurnost i usklađenost s propisima.</b>                           | Română      | · Consultați manualul referitor la <b>siguranță și reglementare.</b> |
| Deutsch     | · Lesen Sie die <b>Sicherheitsanweisungen und Richtlinien.</b>       | Shqip      | · Lexoni paragrafin " <b>Siguria dhe rregullimi.</b> "                             | Български   | · Прочетете <b>Безопасност и регулаторни стандарти.</b>              |
| Français    | · Lire le document <b>Sécurité et mesures réglementaires.</b>        | Bosanski   | · Pročitajte dio <b>Sigurnost i propisi.</b>                                       | Eesti       | · Lugege <b>ohutus- ja normatiivteavet.</b>                          |
| Italiano    | · Leggere il manuale <b>Sicurezza e normativa.</b>                   | Македонски | · Прочитajte за <b>безбедноста и регулативата.</b>                                 | Lietuvių k. | · Perskaitykite <b>Saugos ir norminius reikalavimus.</b>             |
| Español     | · Leer <b>Seguridad y normativa.</b>                                 | Svenska    | · Läs <b>Säkerhet och föreskrifter.</b>  | Latviešu    | · Izlasiet sadaļu <b>Drošība un normatīvi.</b>                       |
| Português   | · Ler informações sobre a <b>Segurança e Regulamentos.</b>           | Magyar     | · Biztonsági szabályzat megtekintése.  | Srpski      | · Pročitajte odeljak <b>Bezbednost i regulatorna pitanja.</b>        |
| Nederlands  | · <b>Veiligheidsinformatie en regelgeving</b> lezen.                 | Polski     | · Prosimy o przeczytanie <b>Zasad bezpieczeństwa i uwag dotyczących przepisów.</b> | Norsk       | · Les <b>sikkerhet og forskrifter.</b>                               |
| Ελληνικά    | · Διαβάστε τις <b>οδηγίες για την ασφάλεια και τους κανονισμούς.</b> | Česky      | · Přečtěte si část <b>Bezpečnost a zákonné předpisy.</b>                           | Dansk       | · Læs <b>sikkerhed og lovmæssige bestemmelser.</b>                   |
| Slovenščina | · Preberite <b>varnostne in regulativne vidike.</b>                  | Slovenčina | · Prečítajte si <b>bezpečnostné a regulačné informácie.</b>                        | Suomi       | · Lue <b>Turvallisuus ja säännökset</b> -osio.                       |

+ : Depending on model / Abhängig vom Modell / Selon le modèle / In base al modello / En función del modelo / Dependendo do modelo / Afhankelijk van het model / Αν λογα με το μοντ λο / Odvisno od modela / Tipusfüggő / Zależnie od modelu / Závisí na modelu / V závislosti od modelu / În funcție de model / в зависимости от модели / Sõltub mudelist / Priklauso nuo modelio / Atkarībā no modeļa / U zavisnosti od modela / Ovisno o modelu / Né varási tē modelit / Ovisno o modelu / во зависност од моделот / Beroende på modell / Avhengig av modell / Afhängigt af modellen / Mallin mukaan