



RAZER KRAKEN V3 X

MASTER GUIDE

Win the long game with the **Razer Kraken V3 X**—the ultra-light USB gaming headset made for gaming marathons. With an upgraded mic and drivers for greater sound, improved ear cushions for greater comfort, and Razer Chroma™ RGB for greater flair, your gaming is set to go the distance.

.

CONTENTS

1. WHAT'S INSIDE / WHAT'S NEEDED	3
2. LET'S GET YOU COVERED	5
3. TECHNICAL SPECIFICATIONS	6
4. GETTING STARTED.....	7
5. USING THE HEADSET	9
6. CONFIGURING YOUR RAZER KRAKEN V3 X VIA RAZER SYNAPSE	11
7. SAFETY AND MAINTENANCE	21
8. LEGALESE	22

1. WHAT'S INSIDE / WHAT'S NEEDED

WHAT'S INSIDE

- Razer Kraken V3 X

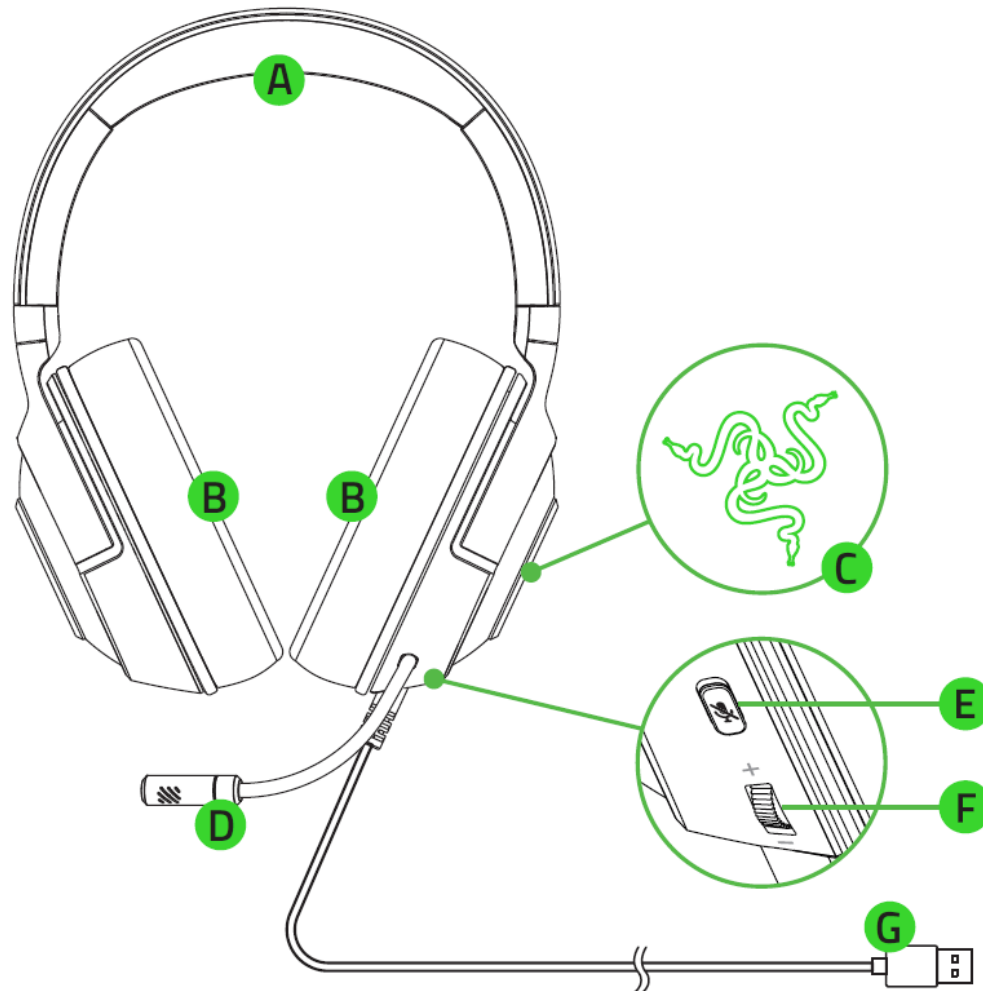

- A. Adjustable padded headband
- B. Hybrid fabric and memory foam ear cushions
- C. Backlit Razer logo Powered by Razer Chroma™ RGB
- D. Razer™ HyperClear cardioid mic
- E. Mic mute button
- F. Volume control wheel
- G. USB connector

- Important Product Information Guide

WHAT'S NEEDED

PRODUCT REQUIREMENTS

- Windows® OS
- USB-A port

RAZER SYNAPSE REQUIREMENTS

- Windows® 10 64-bit (or higher)
- Internet connection for software installation

2. LET'S GET YOU COVERED

You've got a great device in your hands, complete with a 2-year limited warranty coverage. Now maximize its potential and score exclusive Razer benefits by registering at razerid.razer.com

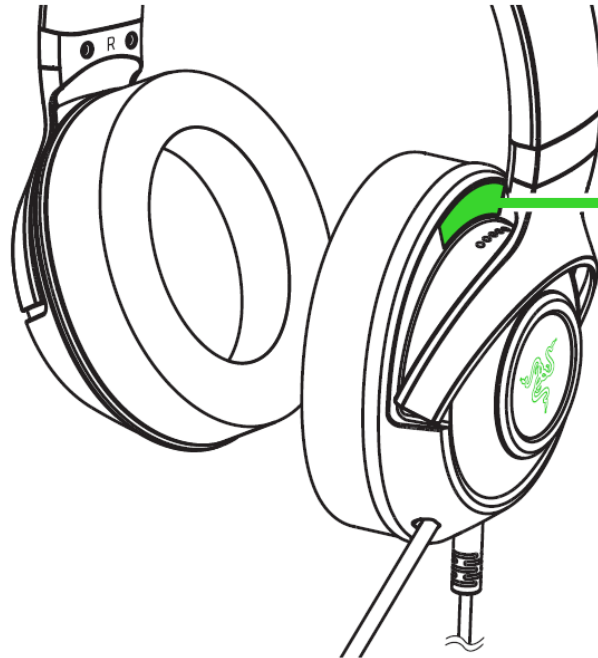

*Your product's
serial number
can be found
here.*

Got a question? Ask the Razer Support Team at support.razer.com

3. TECHNICAL SPECIFICATIONS

HEADPHONES

- Frequency response: 12 Hz – 28 kHz
- Impedance: 32 Ω @ 1 kHz
- Sensitivity (@1 kHz): 103dB SPL/mW, 1KHz
- Drivers: Customized Dynamic 40mm Driver
- Inner ear cup diameter: 60 x 40mm
- Connection type: USB Type A
- Approx. weight: 285g / 0.63lbs
- Oval ear cushions: Full-ear coverage with fabric and plush leatherette, for sound isolation and comfort

MICROPHONE

- Frequency response: 100 Hz – 10 kHz
- Signal-to-noise ratio: ≥ 60 dB
- Sensitivity (@1 kHz): -42 ± 3 dB
- Pick-up pattern: Unidirectional

ON-EARCUP CONTROLS

- Volume up and down
- Mic mute on/off toggle

AUDIO USAGE

- Wired audio usage: USB Type A
- Surround sound: Only available on Windows® 10 64-bit

4. GETTING STARTED

SETTING IT UP

1. Connect the headset to the USB port of your PC.

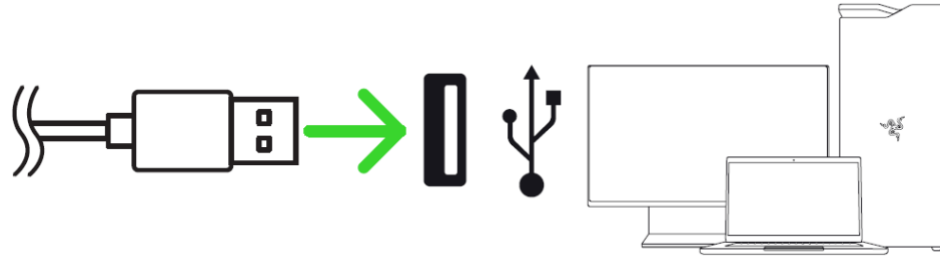

2. On your PC, right-click on the sound icon on the system tray, and then select **Open Sound settings**

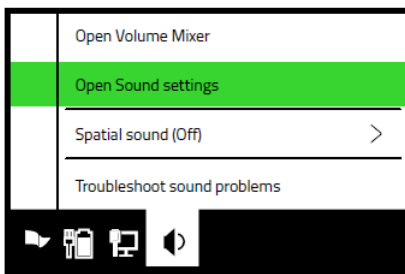

3. On the **Sound** window, set **Razer Kraken V3 X** as the default **Output** and **Input** device.

Sounds

Output

Choose your output device

Razer Kraken V3 X

Input

Choose your input device

Razer Kraken V3 X

4. Use the Razer Synapse* app to customize your headset's lighting for an immersive gaming experience that's truly yours.

**Install Razer Synapse when prompted or download the installer from [razer.com/synapse](https://www.razer.com/synapse).*

ACTIVATE THE 7.1 SURROUND SOUND*

Experience accurate positional sound that's specifically designed for games, movies, and music.

1. Download the 7.1 Surround Sound software from [razer.com/7.1-surround-sound](https://www.razer.com/7.1-surround-sound).
2. Register your product at razerid.razer.com/products to get your activation code sent to your email.

**Only available on Windows® 10 64-bit*

5. USING THE HEADSET

ADJUSTING THE VOLUME

Rotate the volume control wheel as shown to increase or decrease the volume.

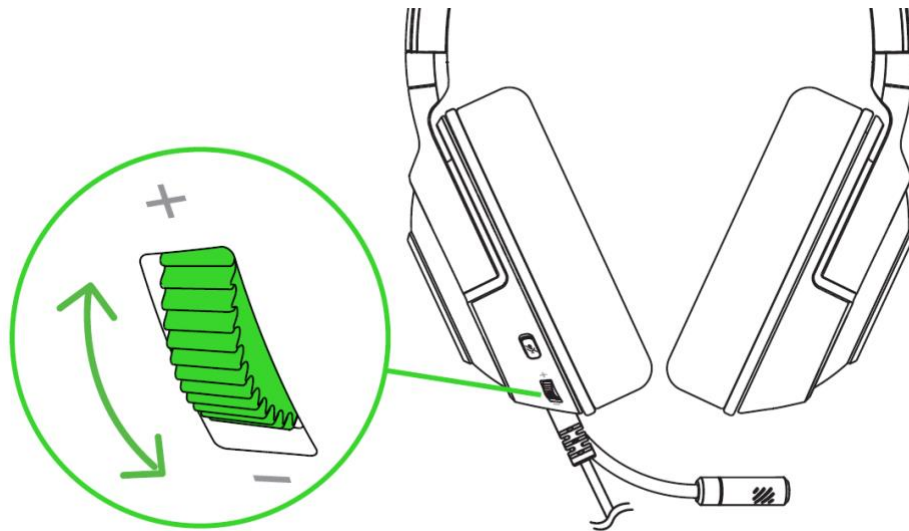

USING THE MICROPHONE

Bend the mic until it is parallel to your mouth. Make sure the mic diaphragm is in front and the air vent is facing away from your mouth.

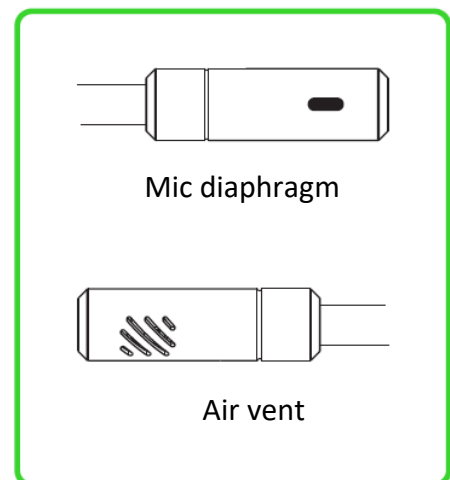
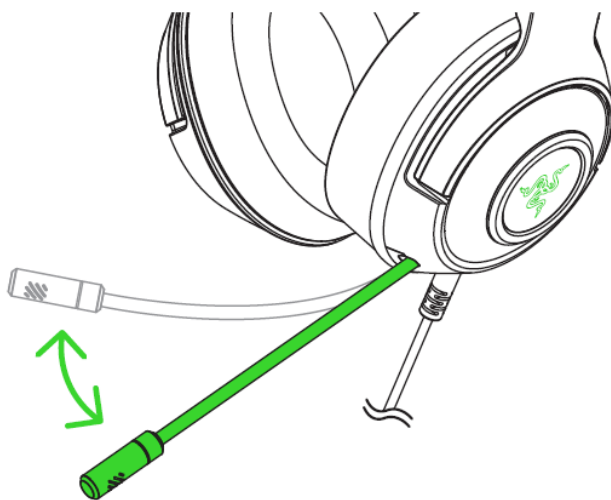

USING THE MIC MUTE BUTTON

Press the mic mute button to mute or unmute the microphone.

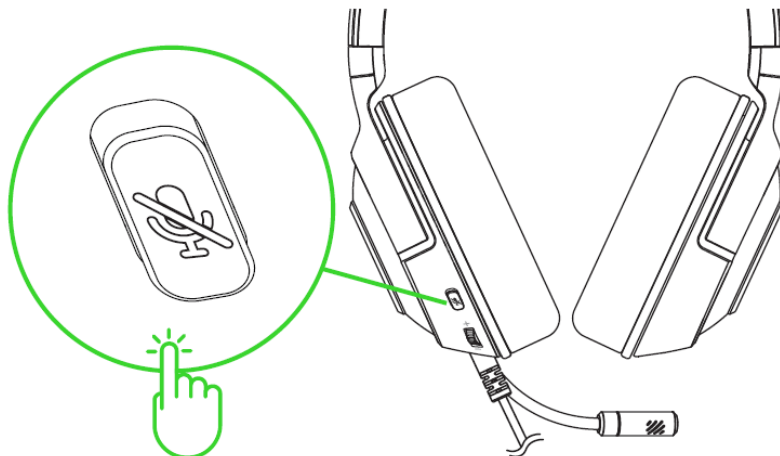

COMFORT

We recommend stretching the headset gently apart before placing them over your head to minimize headband stress. However, please avoid overstretching the headset beyond its technical limits.

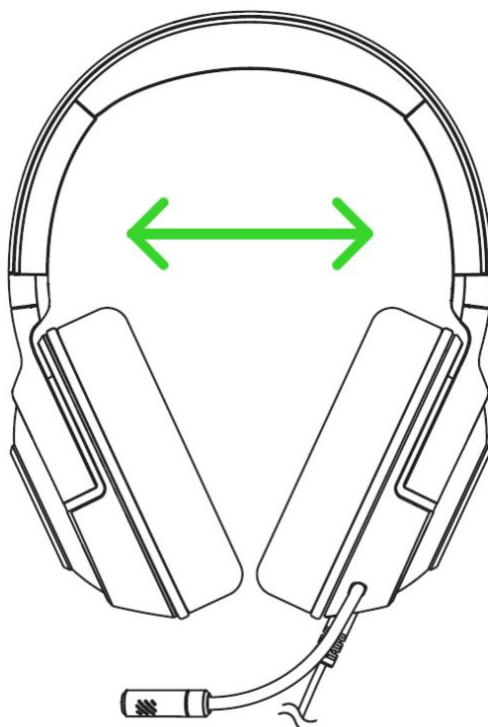

6. CONFIGURING YOUR RAZER KRAKEN V3 X VIA RAZER SYNAPSE

i *Internet connection is required for installation, updates and cloud-based features. Registering for a Razer ID account is recommended, but optional. All listed features are subject to change based on the current software version, connected device(s), and supported apps and software.*

SYNAPSE TAB

The Synapse tab is your default tab when you first launch Razer Synapse. This tab allows you to navigate the Dashboard subtab.

Dashboard

The Dashboard subtab is an overview of your Razer Synapse where you can access all your Razer devices, modules, and online services.

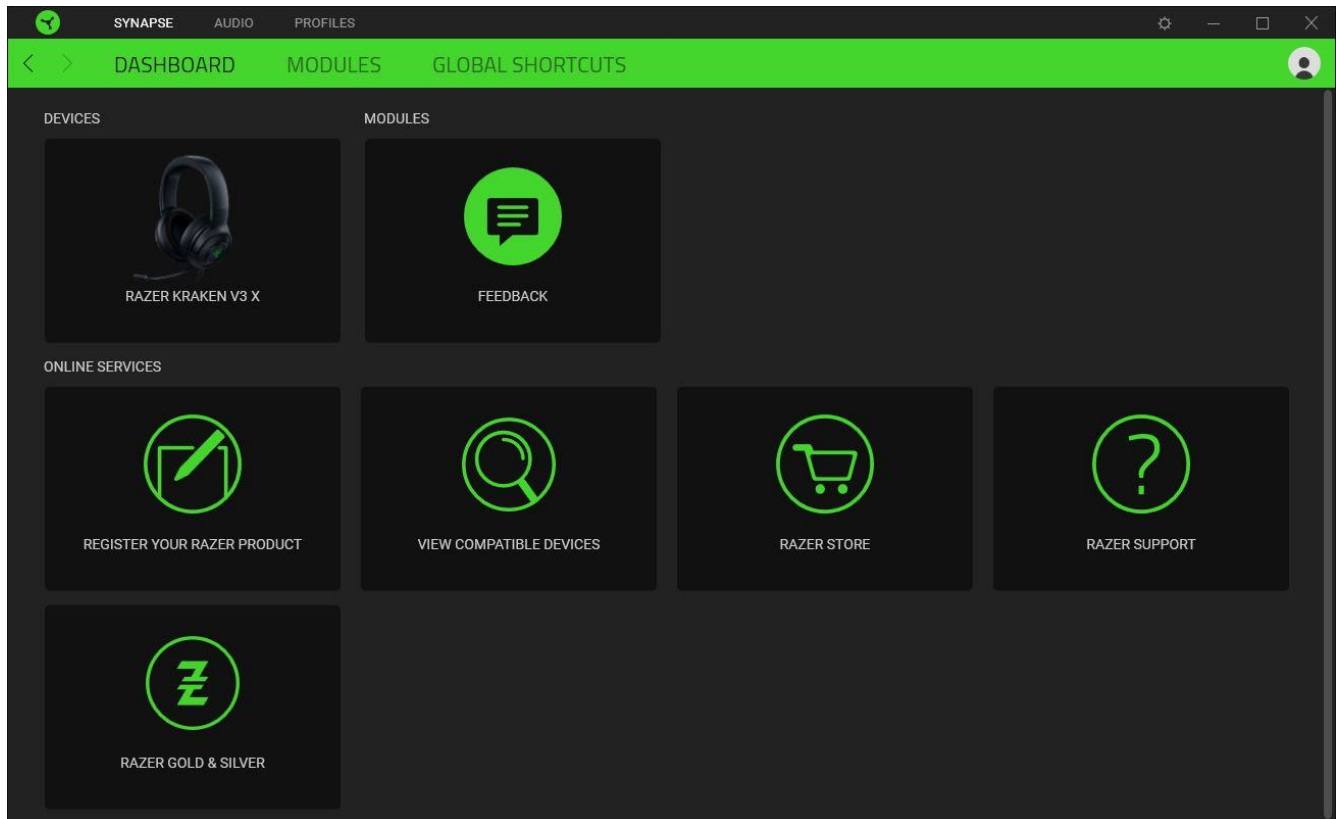

Modules

The Modules subtab displays all installed and available modules for installation.

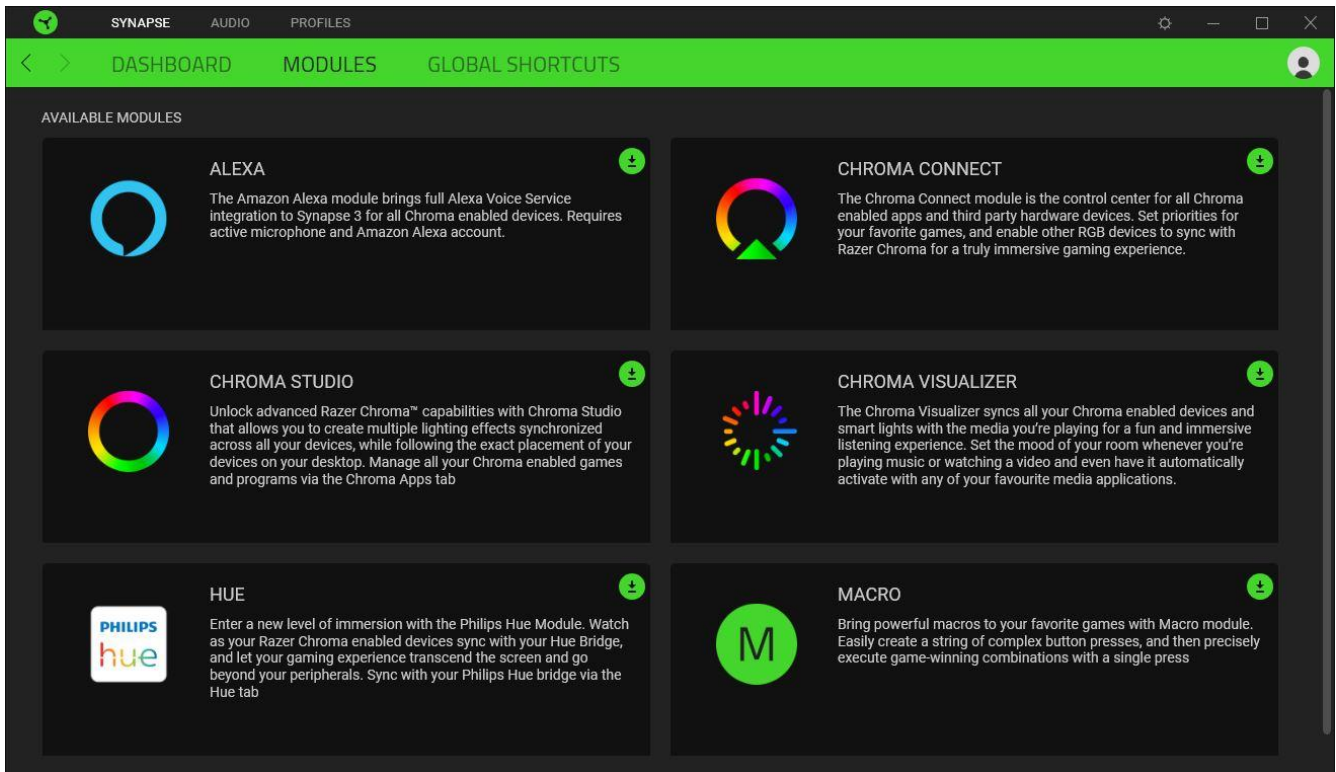

Global Shortcuts

Bind operations or Razer Synapse functions to custom key-combinations from any Razer Synapse-enabled device inputs which apply across all device profiles. [Learn more about Profiles](#)

 *Only Razer Synapse-enabled device inputs will be recognized.*

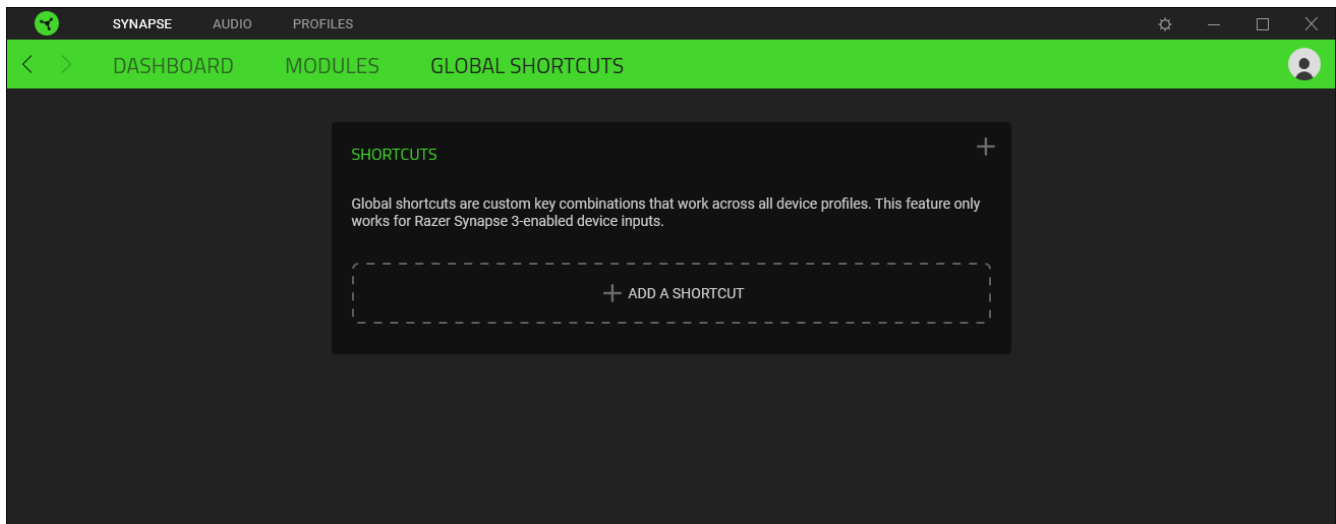

AUDIO TAB

The Audio tab is the main tab for your Razer Kraken V3 X. From here, you can customize your device's settings to unleash its full potential. Changes made under this tab are automatically saved to your system and cloud storage.

Sound

The Sound subtab is for modifying your device's sound properties.

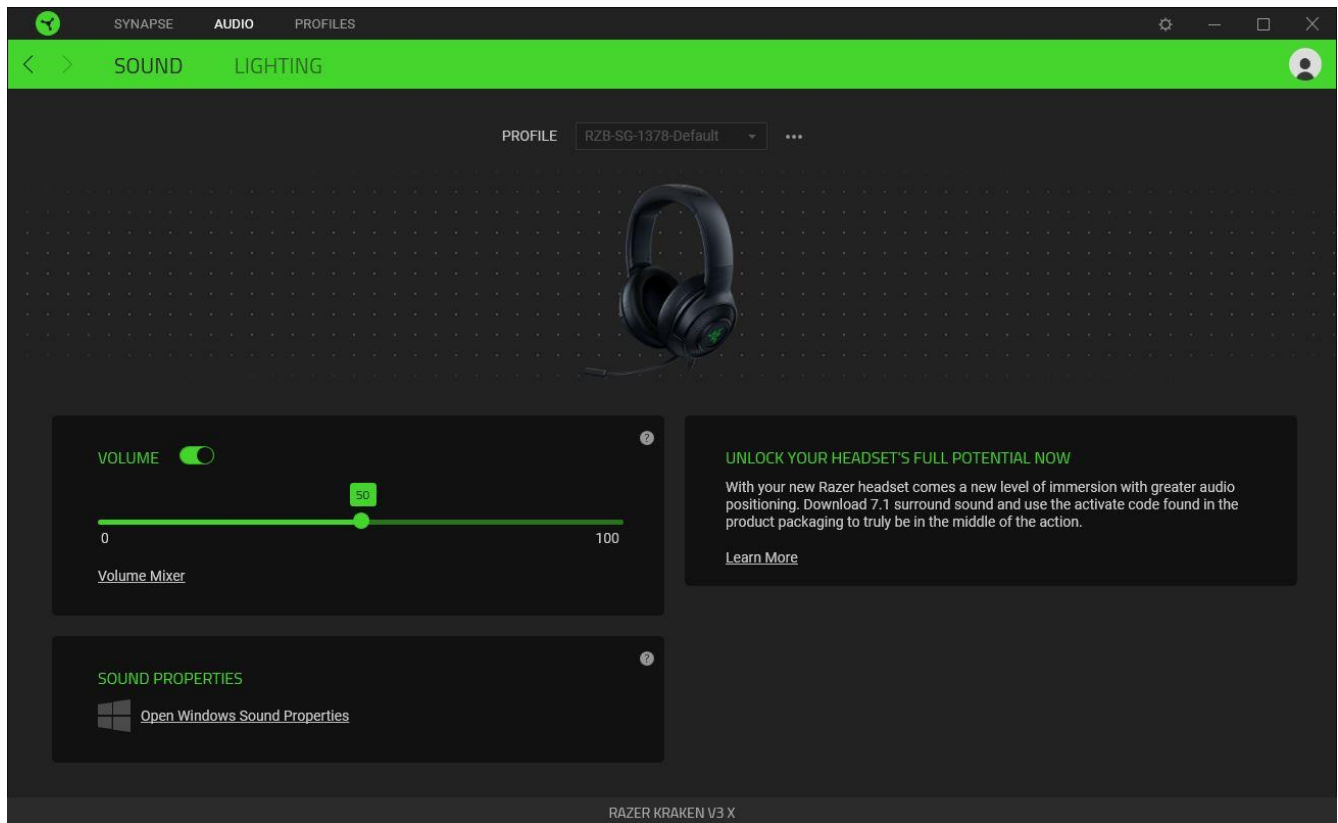

Profile

Profile is a data storage for keeping all your Razer peripheral's settings. By default, the profile name is based on your system's name. To add, rename, duplicate, or delete a profile, simply press the Miscellaneous button (●●●).

Volume

Adjust the audio volume of the device. You may also access the Windows Volume mixer of the current playback device where you can proportionally adjust the overall volume of the system or individually adjust the volume of each active application.

Sound Properties

Launch the Windows sound properties window to manage the sound settings of your system such as modifying the playback and recording device settings, sound scheme and default communications activity.

Lighting

The Lighting subtab enables you to modify your Razer device's light settings.

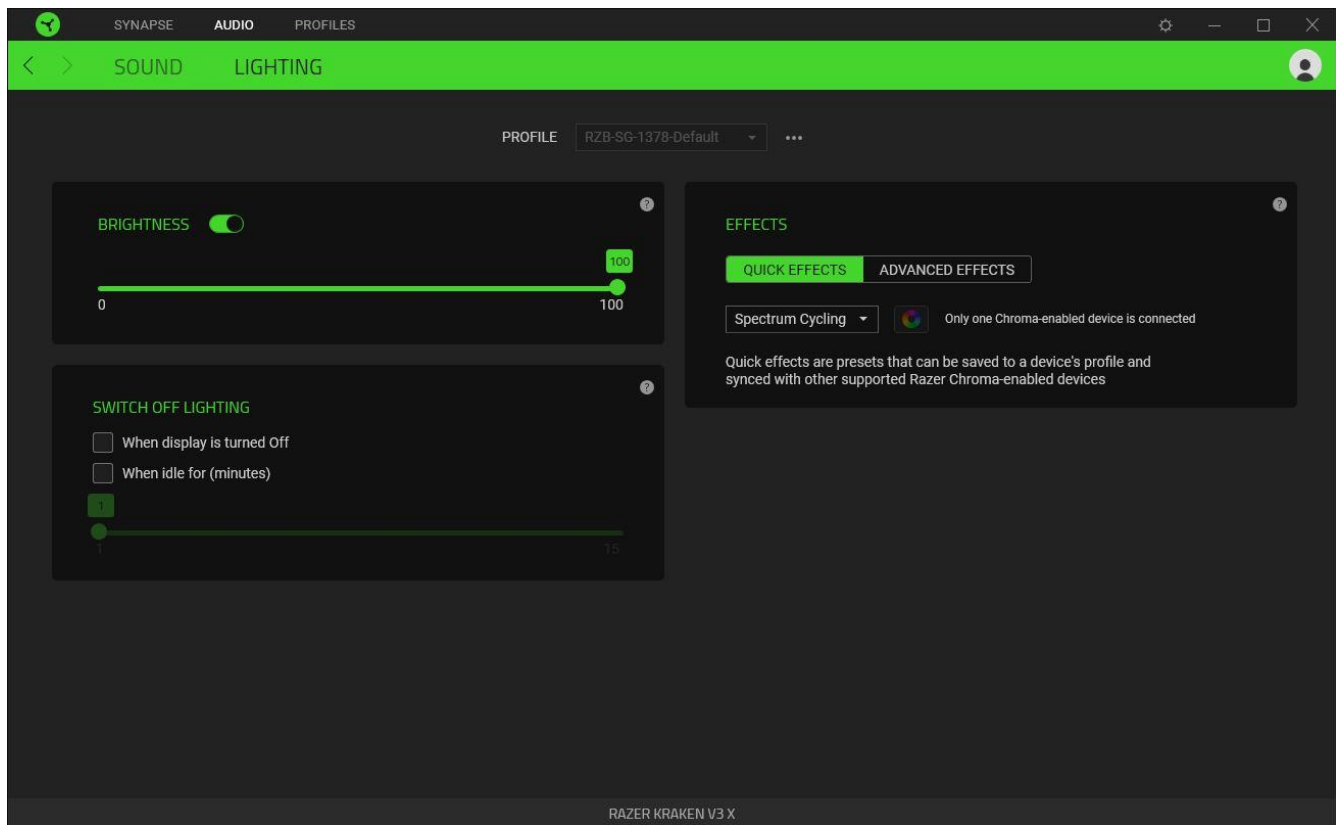

Brightness





You can turn off your Razer device's lighting by toggling the Brightness option or increase/decrease the luminance using the slider.

Switch Off Lighting

This is a power saving tool which allows you to disable your device's lighting in response to your system's display turning off and/or automatically power down when your Razer Kraken V3 X has been idle for a set amount of time.

Effects

A number of effects can be selected and applied to your headset's lighting, as listed here:

	Name	Description	How to set up
	Audio meter	The earcups will light up according to the audio level with a default spectrum of colors	Select a Color Boost level
	Breathing	The lighting will fade in and out of the selected color(s)	Select up to 2 colors or randomize colors
	Spectrum cycling	The lighting will cycle between 16.8 million colors indefinitely	No further customization required
	Static	The earcups will remain lit in the selected color	Select a color

If you have other supported Razer Chroma-enabled devices, you can synchronize their quick effects with your Razer device by clicking the Chroma Sync button ().

 *Only devices that support the selected lighting effect will synchronize.*

Advanced Effects

The Advanced Effects option allows you to choose a Chroma Effect you want to use on your Razer Chroma-enabled peripheral. To start making your own Chroma Effect, simply press the Chroma Studio button ().

 *The Chroma Studio module is required to use this function.*



PROFILES TAB

The Profiles tab is a convenient way of managing all your profiles and linking them to your games and applications.

Devices

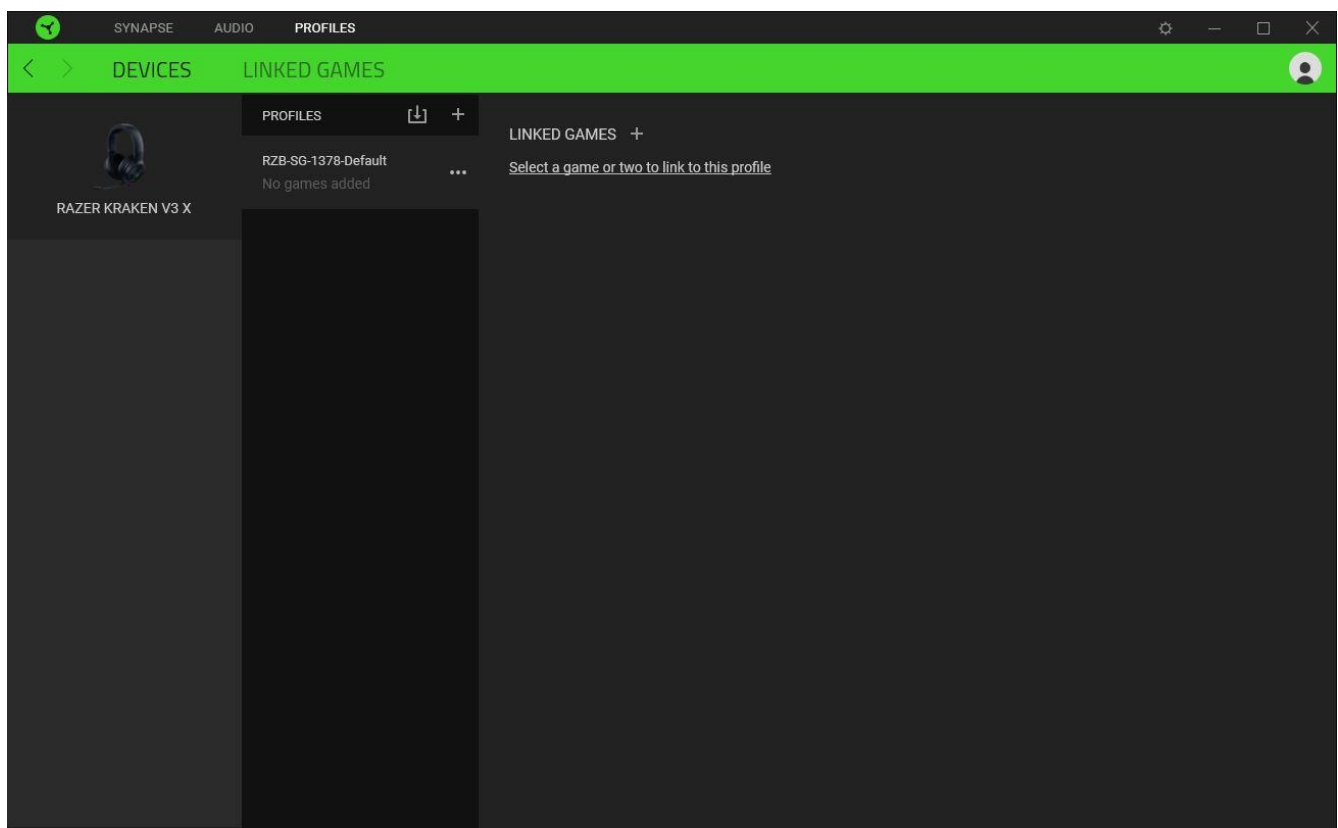
View which games are linked to each device's profiles or which Chroma Effect is linked to specific games using the Devices subtab.



You can import Profiles from your computer or from the cloud through the import button () or create new profiles within the selected device using the add button (). To rename, duplicate, export, or delete a profile, simply press the Miscellaneous button (). Each profile can be set to automatically activate when you run an application using the Linked Games option.

Linked Games

The Linked Games subtab gives you the flexibility to add games, view devices that are linked to games, or search for added games. You can also sort games based on alphabetical order, last played, or most played. Added games will still be listed here even if it is not linked to a Razer device.

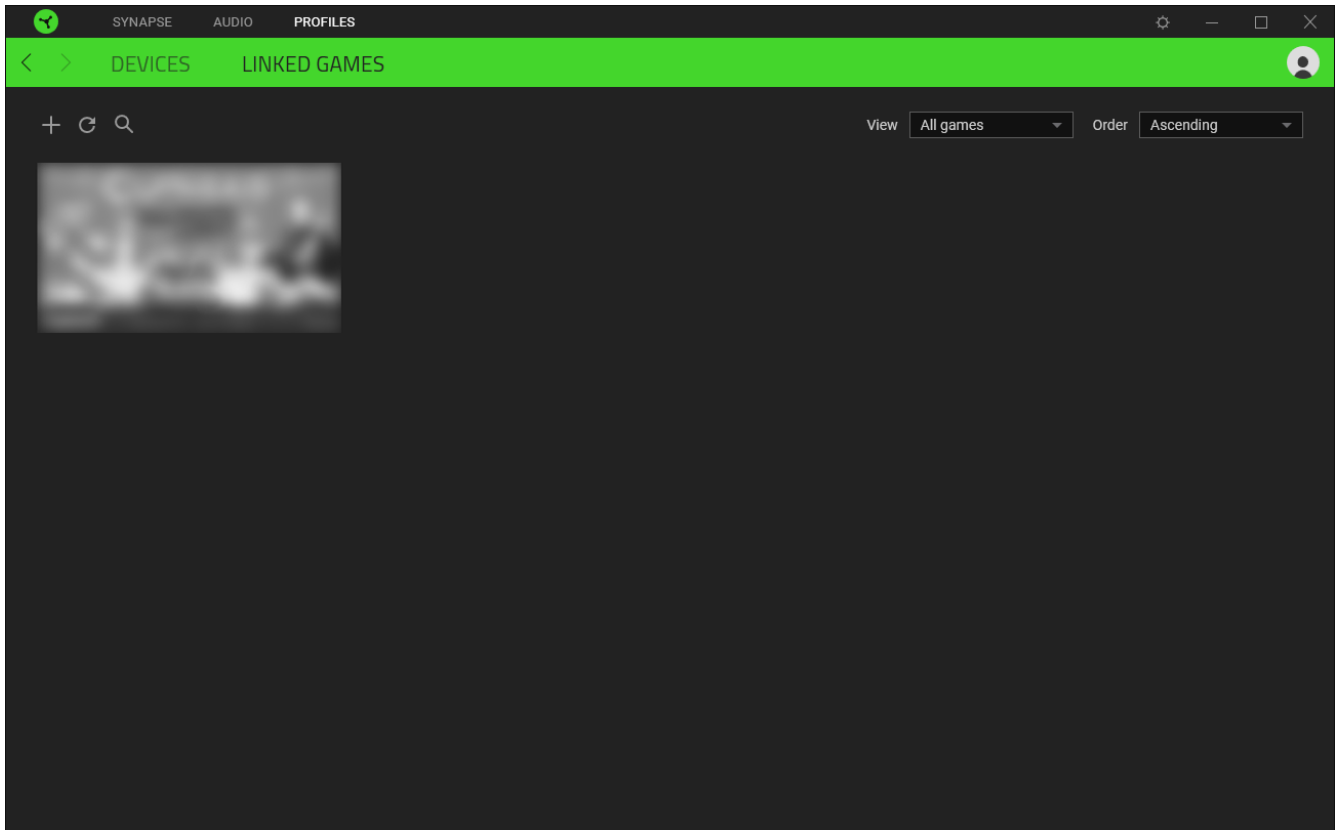

To link games to connected Razer devices or Chroma Effects, simply click on any game from the list, and then click **Select a device and its profile to launch automatically during gameplay** to select the Razer device or Chroma Effect it will link with. Once linked, you may click on the Miscellaneous button (●●●) of the corresponding Chroma Effect or device to select a specific Chroma Effect or profile.

SETTINGS WINDOW

The Settings window, accessible by clicking the (⚙) button on Razer Synapse, enables you to configure the startup behavior and display language of Razer Synapse, view the master guides of each connected Razer device, or perform factory reset on any connected Razer device.

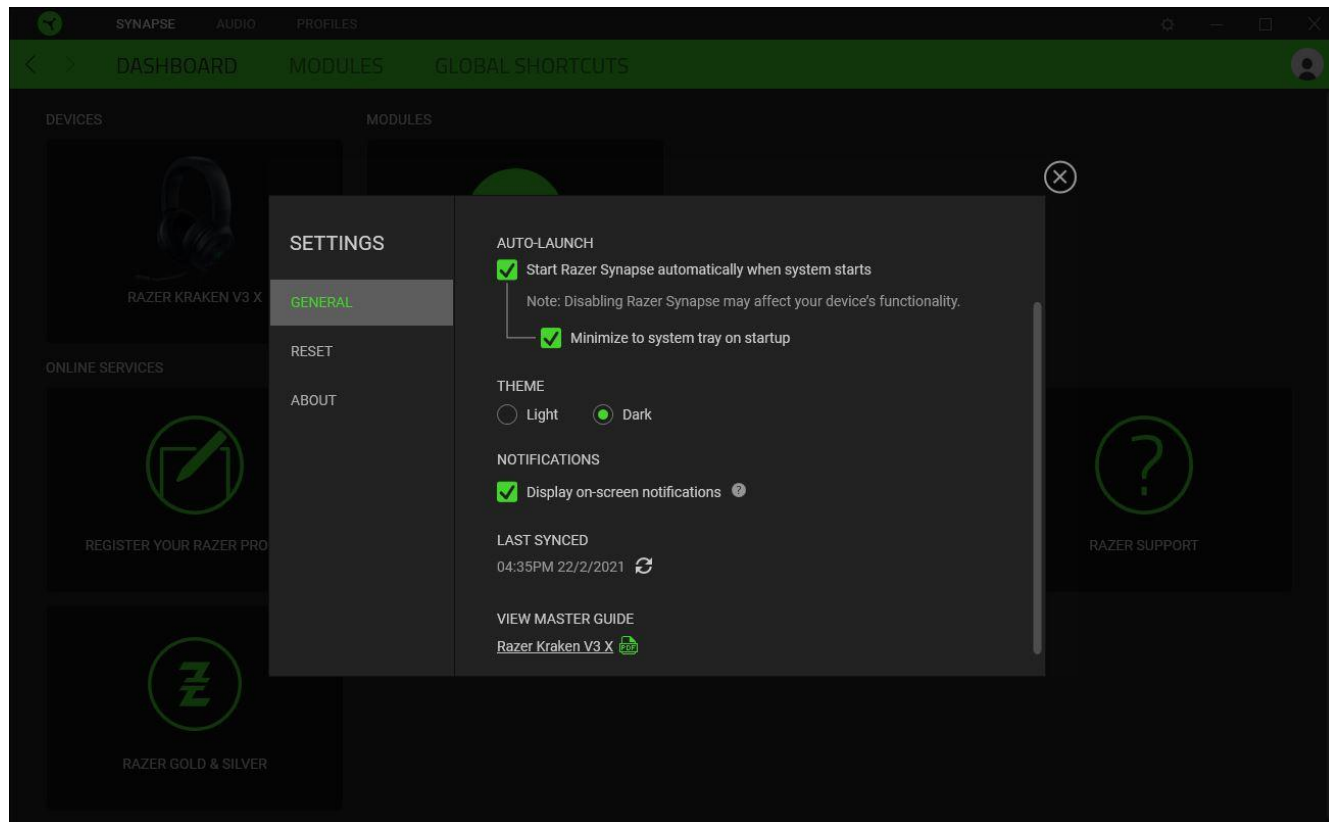

General tab

The default tab of the Settings window. The General tab enables you to change the software's display language, start-up behavior, display theme, and on-screen notifications display. You may also manually sync your profiles to the cloud (↻) or view the master guide of all connected Razer devices and installed modules.

Reset tab

The Reset tab allows you to perform a factory reset on all connected Razer devices with on-board memory and/or reset Razer Synapse tutorials to acquaint yourself again with Razer Synapse's new features on its next launch.

 *By resetting a Razer device, all profiles stored on the selected device's on-board memory will be erased.*

About tab

The About tab displays brief software information, copyright statement and provides relevant links for its terms of use. You may also use this tab to check for software updates, or as a quick access to Razer's social communities.

7. SAFETY AND MAINTENANCE

SAFETY GUIDELINES

In order to achieve maximum safety while using your Razer Kraken V3 X, we suggest that you adopt the following guidelines:

Should you have trouble operating the device properly and troubleshooting does not work, unplug the device and contact the Razer hotline or go to support.razer.com for assistance.

Do not take apart the device and do not attempt to operate it under abnormal current loads. Doing so will void your warranty.

Keep the device away from liquid, humidity or moisture. Operate the device only within the specific temperature range of 0°C (32°F) to 40°C (104°F). Should the temperature exceed this range, unplug the device in order to let the temperature stabilize to an optimal level.

The device isolates external ambient sounds even at low volumes, resulting in lowered awareness of your external surroundings. Please remove the device when engaging in any activities that requires active awareness of your surroundings.

Listening to excessively loud volumes over extended periods of time can damage your hearing. Furthermore, legislation of certain countries permits a maximum sound level of 86db to affect your hearing for 8 hours a day. We therefore recommend that you reduce the volume to a comfortable level when listening for prolonged periods of time. Please, take good care of your hearing.

MAINTENANCE AND USE

The Razer Kraken V3 X requires minimum maintenance to keep it in optimum condition. Once a month we recommend you clean it using a soft cloth or cotton swab to prevent dirt buildup. Do not use soap or harsh cleaning agents.

8. LEGALESE

COPYRIGHT AND INTELLECTUAL PROPERTY INFORMATION

©2021 Razer Inc. All rights reserved. Razer, the triple-headed snake logo, Razer logo, and “For Gamers. By Gamers.” are trademarks or registered trademarks of Razer Inc. and/or affiliated companies in the United States or other countries. All other trademarks are the property of their respective owners.

Windows and the Windows logo are trademarks or registered trademarks of the Microsoft group of companies.

Razer Inc. (“Razer”) may have copyright, trademarks, trade secrets, patents, patent applications, or other intellectual property rights (whether registered or unregistered) concerning the product in this guide. Furnishing of this guide does not give you a license to any such copyright, trademark, patent or other intellectual property right. The Razer Kraken V3 X (the “Product”) may differ from pictures whether on packaging or otherwise. Razer assumes no responsibility for such differences or for any errors that may appear. Information contained herein is subject to change without notice.

LIMITED PRODUCT WARRANTY

For the latest and current terms of the Limited Product Warranty, please visit [razer.com/warranty](https://www.razer.com/warranty).

LIMITATION OF LIABILITY

Razer shall in no event be liable for any lost profits, loss of information or data, special, incidental, indirect, punitive or consequential or incidental damages, arising in any way out of distribution of, sale of, resale of, use of, or inability to use the Product. In no event shall Razer’s liability exceed the retail purchase price of the Product.

GENERAL

These terms shall be governed by and construed under the laws of the jurisdiction in which the Product was purchased. If any term herein is held to be invalid or unenforceable, then such term (in so far as it is invalid or unenforceable) shall be given no effect and deemed to be excluded without invalidating any of the remaining terms. Razer reserves the right to amend any term at any time without notice.