

airwrap

co-anda 2x

User manual



SV12 JN.00000 PN.000000-00-00
00.00.00 VERSION NO.01

Contents

In the box

Activating i.d. curl™ sequence

Getting to know your device

Intelligent attachments

Pause detect

Bluetooth® wireless technology

Styling attachments

Using your attachments

Pre-styling

Curling

Shaping

Smoothing

Volumising

Regular filter maintenance

dyson

In the box

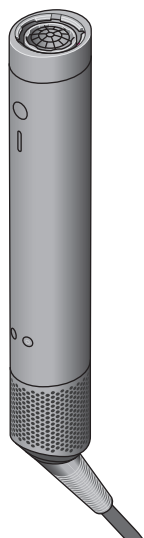

Dyson Airwrap
Co-anda2x™
multi-styler and
dryer main body

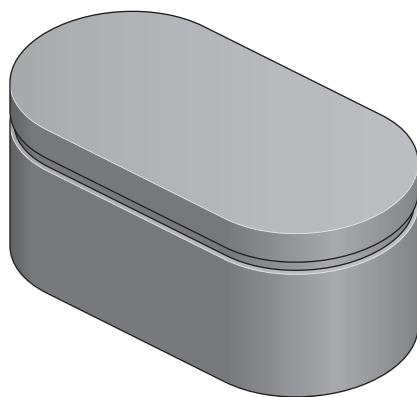

Presentation case

Your device may not include all attachments shown below.

You can buy additional attachments at www.dyson.com.au/hair-care/accessories or dyson.co.nz/hair-care/accessories



30mm
Co-anda2x™
curling barrel



40mm
Co-anda2x™
curling barrel



Fast dryer 2x



Anti-s snag
loop brush 2x



Round
volumising
brush 2x



Airstooth2x™

Activate easier curling when you enable your i.d. curl™ sequence in the MyDyson™ app

Setting up your personalised curl sequence is quick and easy. It takes under two minutes.

Step 1

Download the MyDyson™ app.



Step 2

Set up your hair profile and enable i.d. curl™ personalised curling sequence in the MyDyson™ app.

Step 3

Attach a curling barrel to your device. Press the Power button to activate the sequence.

Your Dyson Airwrap Co-anda2x™ multi-styler and dryer will then wrap, style, set and release consistent curls, automatically adjusting heat and airflow based on the best settings for your hair.



MyDyson™ app connectivity

App functionality may vary per market. Requires internet connection. Operating system and mobile device requirements for the MyDyson™ app can be found on the App Store or Google Play.

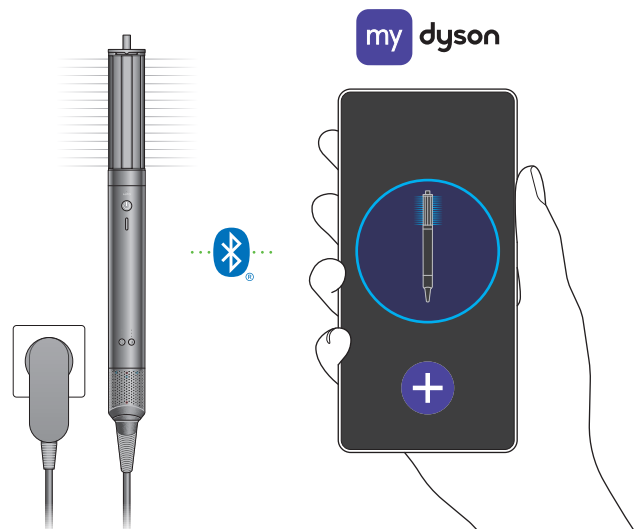

Apple, the Apple logo and Siri are trademarks of Apple Inc., registered in the U.S. and other countries. App Store is a service mark of the Apple Inc., registered in the U.S. and other countries. Google Play, the Google Play logo, Google Assistant are trademarks of Google Inc. The Bluetooth® word mark and logos are registered trademarks owned by Bluetooth SIG, Inc. and any use of such marks by Dyson is under license.

Getting to know your Dyson Airwrap Co-anda2x™ multi-styler and dryer

Attachment learning

On first use, your device will default to the best temperature and airflow settings recommended for each attachment.

You can change these as you style, and your device will remember your go-to styling preferences.

Power button

Activates airflow for all attachments and initiates automatic features. (Curling barrel and AirSmooth™ only).

Temperature control

Four heat settings, including constant cold.

Airflow control

Three airflow speeds – high, medium and low.

Bluetooth® wireless technology LED

Indicates the device is connected to the MyDyson™ app.

Flashing blue – connecting.

Constant blue – connected.

Auto LED

Indicates an attachment with automated features is attached, and the automated feature is enabled (Curling barrel and AirSmooth™ only).

With airflow off, you can disable automated features by holding the Power button for five seconds – until the Auto LED lights up. Hold again to re-enable.

Cold shot

Shaped for easy recognition. Hold to deactivate the heating element to set your style.

Filter LED

Flashing white – no filter detected
Amber – filter cleaning needed.

If the LED continues to flash amber after the filter has been cleaned, contact the Dyson Helpline.

Removable filter

Easy to remove for cleaning (see the 'Regular filter maintenance' section for details).



Intelligent attachments

Your device will only work when an Intelligent attachment is clicked into place.

RFID chips within each attachment communicate with your Dyson Airwrap Co-anda2x™ multi-styler and dryer, to instantly adapt to the best temperature and airflow settings recommended for each attachment.

You can change these as you style, and your device will remember your go-to styling preferences.

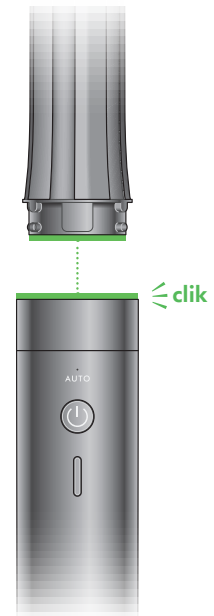

Pause detect

Pause detect uses a motion-sensing accelerometer to know when the device stops moving – automatically deactivating heat and airflow, reducing unnecessary noise.

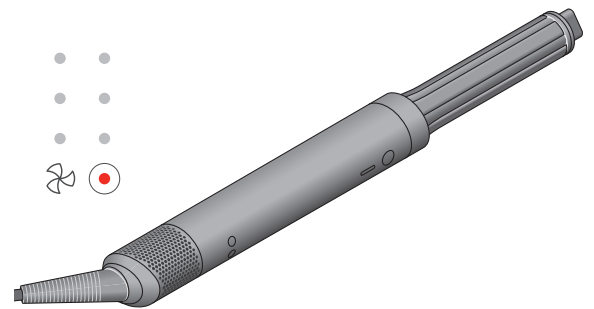

Bluetooth® wireless technology to connect to the MyDyson™ app

Connect your Dyson Airwrap Co-anda2x™ multi-styler and dryer to the MyDyson™ app to get the best from your device.

A hair profile tailored to you

Answer a few simple questions about your hair type, length and style, for personalised tips and advice.

Faster, easier, more consistent curls.¹

Uses your hair profile to automatically adjust heat and airflow for each stage of your styling sequence. For consistent curls, at the touch of a button.



1. vs. original Dyson Airwrap™ multi-styler and dryer.

Styling attachments

All attachments easily click into place. When removing an attachment, we recommend holding the cooler edges of the Anti-s snag loop brush 2x, tips of the AirSmooth2x™ attachment, or coloured cool tips of the attachments.

	Styling attachment	Heat and airflow presets	Works with Auto feature
	30mm Co-anda2x™ curling barrel Create voluminous curls and waves in both directions with one barrel. Increased Coanda airflow wraps hair faster for easier styling. ¹	High heat High flow	Yes
	40mm Co-anda2x™ curling barrel Create loose curls and waves in both directions with one barrel. Increased Coanda airflow wraps hair faster for easier styling. ¹	High heat High flow	Yes
	Anti-s snag loop brush 2x Gives a smoother, more aligned finish. ² Designed for all hair types. New loop bristles reduce snagging while improving comfort on the scalp.	High heat High flow	No
	Round volumising brush 2x Creates voluminous styles with reduced frizz. ² Controlled airflow and tapered bristles allow you to style a section at a time, without disturbing surrounding hair.	High heat High flow	No
	AirSmooth2x™ attachment Uses high velocity airflow to deliver the tension needed to create straighter styles. ³ Use as a finishing attachment on dry hair.	High heat Low flow	Yes
	Fast dryer 2x Controls higher velocity airflow for faster drying. ¹ Take hair from wet to dry or pre-dry for further styling.	High heat High flow	No

Your device may not include all attachments listed.

1. vs. Dyson Airwrap i.d.™ multi-styler and dryer. 2. vs. untreated/naturally dried hair. 3. vs. styling with the Anti-s snag loop brush 2x. 4. vs. Dyson Airwrap™ Wide-tooth comb.

Using your attachments

Connecting the attachment

Click attachment into the main body until it fits securely.

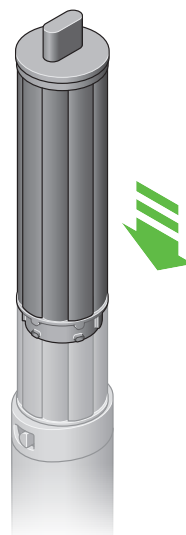

Changing attachments

To change attachment, slide the Release button and remove using the cool tip or edge.

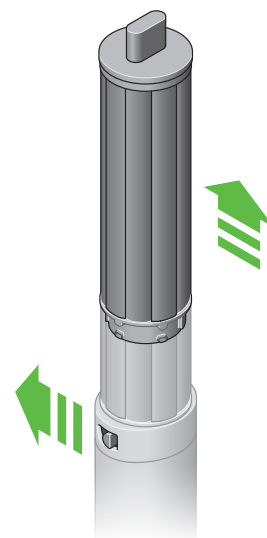

Cool touch tip

During use, the curling barrels and round brushes will get hot. To change to another attachment, hold the tip. If the attachment doesn't have a tip, hold the cool edge.

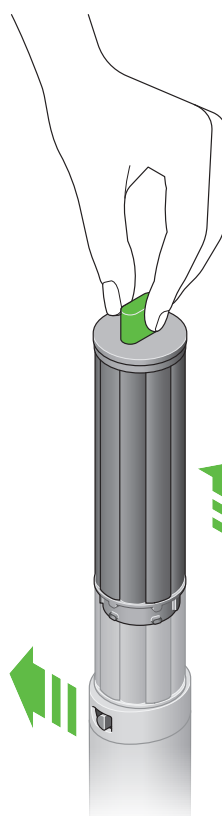

Take care when handling hot attachments

Hold the attachment only in the area indicated.

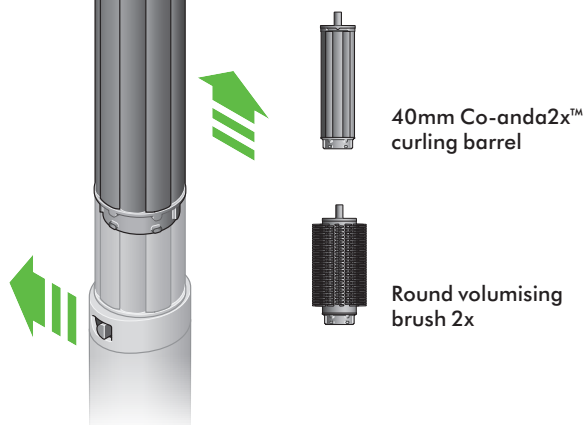

40mm Co-anda2x™
curling barrel

Round volumising
brush 2x

Pre-styling

For straight and wavy hair, use a dryer attachment – Fast dryer 2x.

Hair should look dry but feel cold to the touch before curling with barrels.

For curly and coily hair, use the Anti-snap loop brush 2x. Brush hair downwards in small sections, starting from the ends and working towards the roots, until slightly damp to touch.

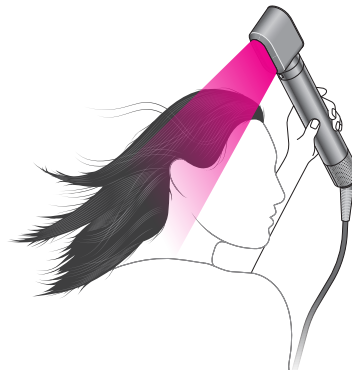

Curling

Using i.d. curl™ personalised curling sequence

The Dyson Airwrap Co-anda2x™ multi-styler and dryer remembers your personalised sequence. This tailors wrapping and styling times to your personal hair profile, using the MyDyson™ app.

First, set up i.d. curl™ personalised curling sequence in the MyDyson™ app.

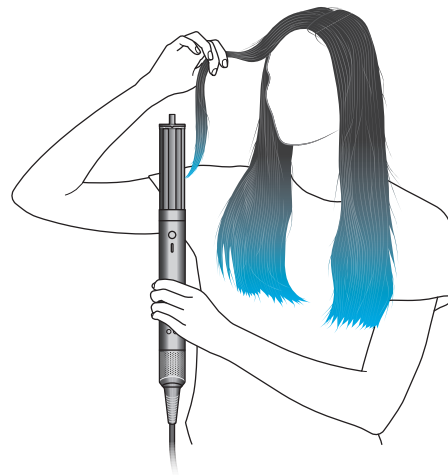

Curling Barrels

Step 1

Press the Power button, then take a section of hair and bring the curling barrel towards tips. Hair will start to wrap around the barrel.

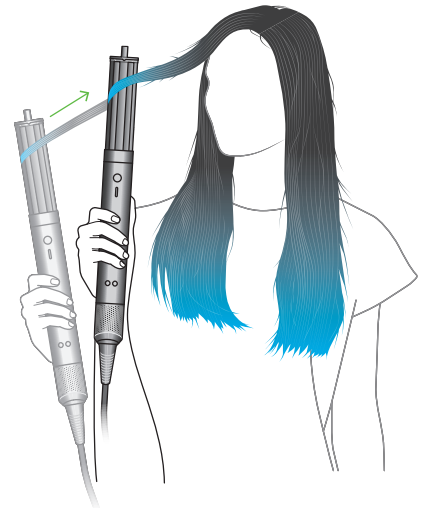

Step 2

Move styler towards head, no need to twist. Your personalised i.d. curl™ sequence will start.

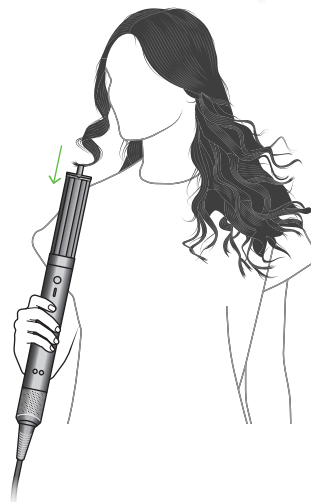

Step 3

Cold shot will automatically activate to set the curl.

Airflow will automatically turn off when sequence is complete.

Move device downwards to release.

To change curl direction, rotate the barrel's cool tip.

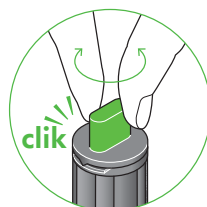

Shaping

Anti-snap loop brush 2x

Use Anti-snap loop brush to brush from root to tip.

Tip:

To create shape, turn brush inwards at the ends.

To maintain volume, face bristles outwards.

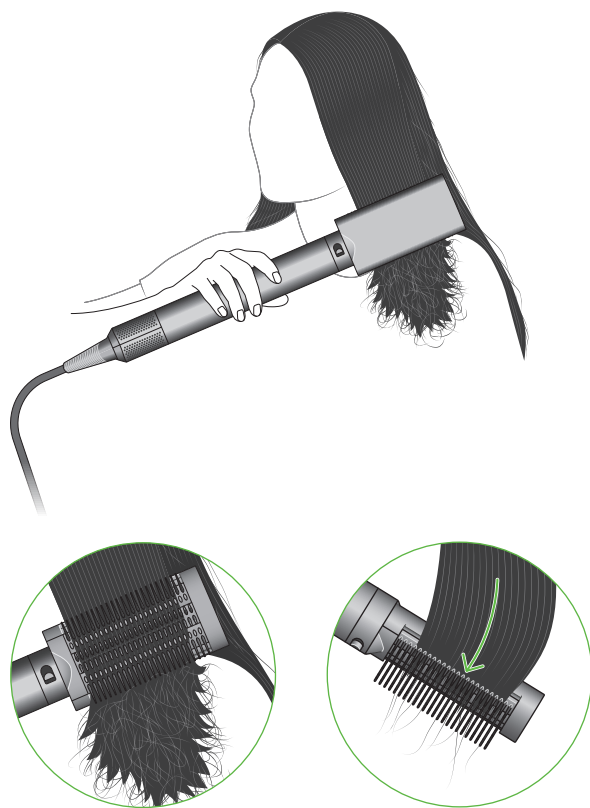

Smoothing

AirSmooth2x™ attachment

Use on dry hair after styling with the Anti-snap loop brush 2x.

Take a section of hair and place it between the attachment's arms.

Press the Power button to clamp arms, and slowly move down the hair.

When Auto mode is enabled, the device will detect when you've completed a full pass, and automatically unclamp to release the hair.

Tip

Slowly move the AirSmooth2x™ attachment through a small section of hair. If the movement is too slow, the device may think you've finished your pass – resulting in the arms opening too soon.

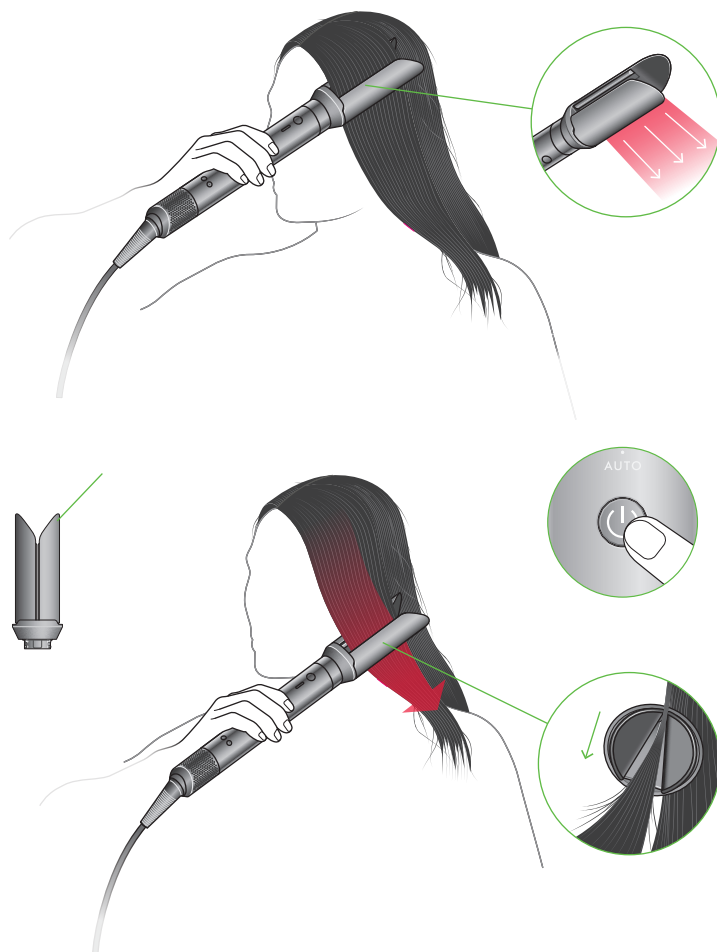

Volumising

Round volumising brush 2x

The Round volumising brush 2x diffuses airflow evenly down the length of the brush, for more controlled styling with less frizz. The tapered bristles pivot to release hair easily as you style.



Tip

Lift sections upwards as you dry to add volume. Wrap hair around and under the brush to shape the ends.

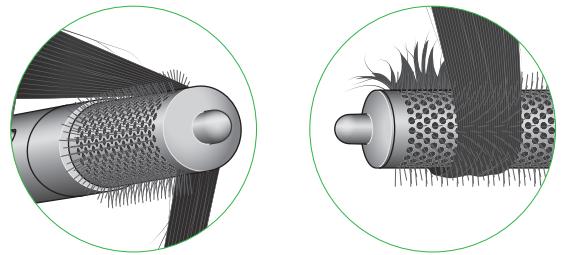

1. vs. untreated/naturally dried hair.

Regular filter maintenance

Filter cleaning is overdue when the Amber LED starts flashing

Ensure that you unplug your device from the mains electricity supply and allow to cool down before cleaning your filter.

Dyson Airwrap Co-anda2x™ multi-styler and dryer has highly tuned technology to give outstanding performance.

This technology needs to be kept free from dust and hair product residue.

Maintenance is required to maintain performance.



Filter mesh



Filter cage

Step 1

Remove the filter by sliding it down the power cord and opening at the split line.

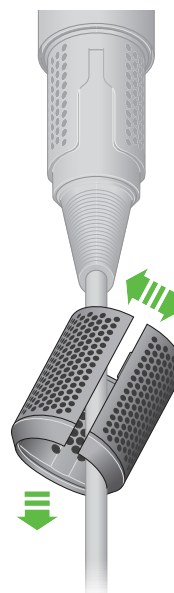

Step 2

Soak the filter in a bowl of water.

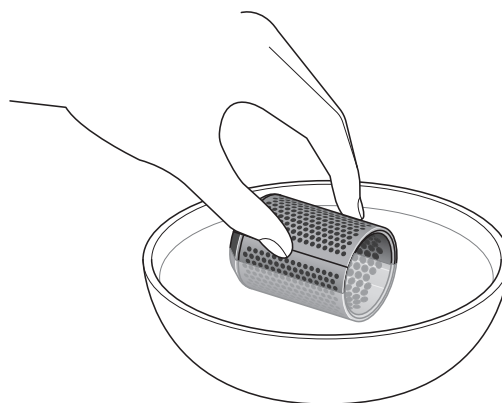

Step 3

Wash the filter cage under a warm, running tap.

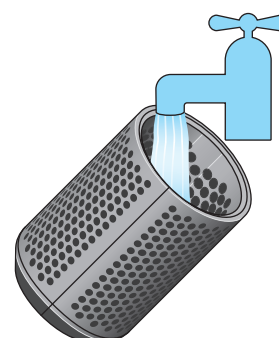

Step 4

Shake the filter cage to remove the majority of the excess water, then leave to dry completely.

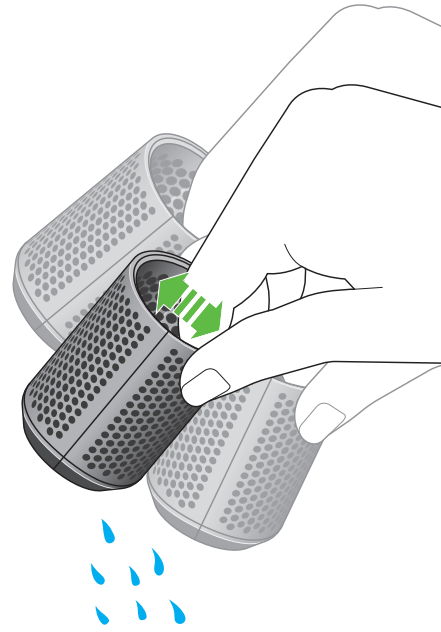

Step 5

Open the filter cage at the split line and replace back on to the device. Click into place.

