

Useful information on humidity

Air always contains a certain amount of water in the form of vapour. This determines the level of humidity in an atmosphere.

The capacity of the air to hold water vapour increases with temperature. This is why in our homes, as soon as the temperature decreases, the vapour contained in the air condenses, as is evident on the colder surfaces in the room, such as the windows, walls etc. The purpose of a dehumidifier is to remove the excess moisture from the air, avoiding the damage caused by condensation.

Experts have established that the optimum environmental conditions for our well being and for the home are obtained between 40% and 60% relative humidity. With temperatures near 5°C, you are recommended to heat the room even minimally. With heating, the condensation formed by the water vapour on windows and other cold surfaces evaporates into the air to be collected by the dehumidifier.

Negative ions change the polarity of airborne particles, causing them to magnetically attract together. As a result, they become too large to remain airborne, and fall out of the air that you breathe in. Negative ions are present in our environment, wherever we feel the air clean and fresh, especially around waterfalls, ocean surf, rivers and mountains. It has been proven that negative ions promote wellness, and, as such, provide additional benefits when there are more negative ions than positive ones in the air we breathe.

IMPORTANT INFORMATION FOR CORRECT DISPOSAL OF THE PRODUCT IN ACCORDANCE WITH EC DIRECTIVE 2002/96/EC.



At the end of its working life, the product must not be disposed of as urban waste. It must be taken to a special local authority differentiated waste collection centre or to a dealer providing this service. Disposing of a household appliance separately avoids possible negative consequences for the environment and health deriving from inappropriate disposal and enables the constituent materials to be recovered to obtain significant savings in energy and resources. As a reminder of the need to dispose of household appliances separately, the product is marked with a crossed-out wheeled dustbin.

Description

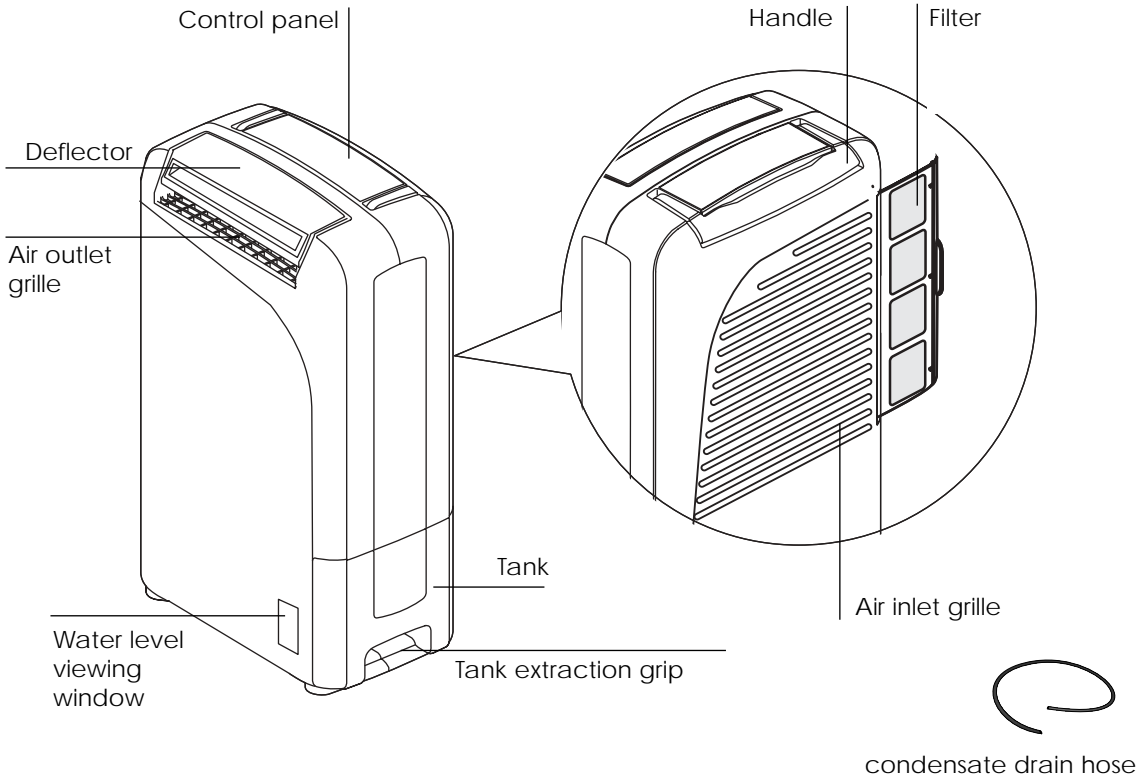

CONTROL PANEL

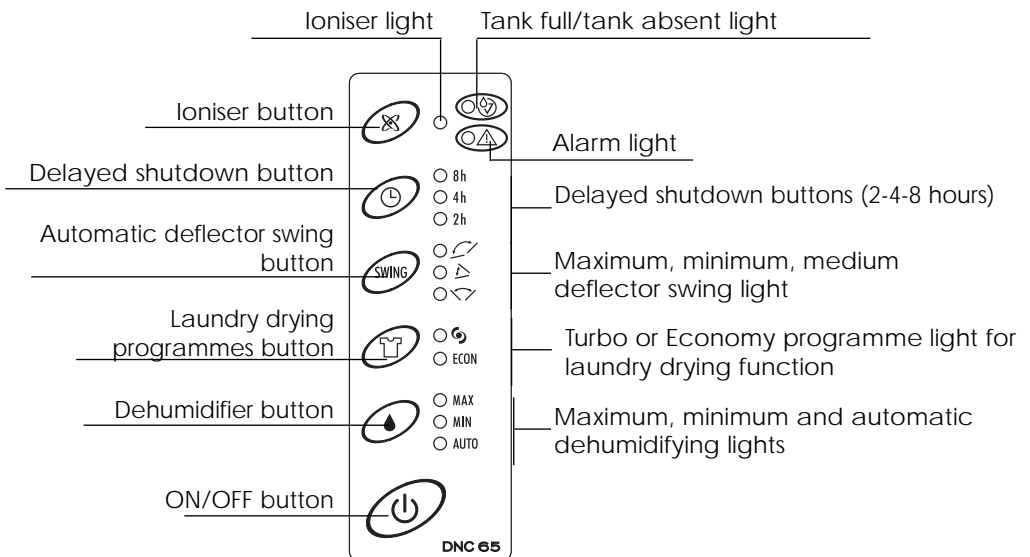

Important safeguards

S SAFETY WARNINGS

- Use this appliance only as described in this instruction manual.
As with all electrical equipment, whilst the instructions aim to cover as many eventualities as possible, caution and common sense should be applied when operating and installing this appliance.
- This appliance is designed to dehumidify domestic rooms and dry laundry and must not be used for other purposes.
- It is dangerous to modify or alter the characteristics of the appliance in any way.
- If the appliance requires repair, always contact a Service Centre authorised by the manufacturer. Always insist on original spare parts. Repairs carried out by unauthorised personnel may be dangerous and invalidate the guarantee.
- Never allow the appliance to be used by people (including children) with psychological, physical or sensory impairments or with insufficient experience and knowledge, unless closely supervised and instructed by someone responsible for their safety. Always supervise children. Make sure they do not play with the appliance.
- If the power cable is damaged, it must be replaced by the manufacturer, an authorised service centre or a qualified electrician in order to eliminate all risk.
- The appliance must be connected to an efficient earth installation. Have your electrical circuit checked by a qualified electrician.
- The use of an extension lead is not recommended, however if it is necessary then follow carefully the extension lead's instructions, and most importantly ensure that the extension lead is correctly rated in accordance with the appliance being used and NEVER overloaded.
- Before cleaning or maintenance operations, always unplug the appliance from the power socket.
- Do not move the appliance by pulling the power cable.
- Never use the appliance in very damp rooms (laundries for example).
- Do not use the appliance on sloping surfaces.
- Keep the appliance at least 50 cm away from flammable substances (alcohol etc) or pressurised containers (e.g. aerosol cans).
- Do not rest heavy or hot objects on top of the appliance.
- Clean the air filter regularly.
- At the end of its working life, consign the appliance to a specialist collection centre.
- The materials used for packaging can be recycled. You are therefore recommended to dispose of them in appropriate waste collection containers.
- Do not use the appliance outdoors.
- Do not obstruct the air intake or outlet.
- Do not insert fingers or other objects into the air intake or outlet openings. Do not insert metal objects into the apertures.
- **Danger! Rotating parts; contact with the internal fan could cause electric shock or injury.**
- Do not drink the water collected from the appliance or use it as animal drinking water.
- Before moving the appliance, turn off the switch and empty the water in the tank. Water could leak out and wet other objects, causing electric shocks or fire.

A Assistance

Please refer to the guarantee leaflet enclosed for service and assistance details.

Installation

Electrical connections

Before plugging the appliance into the mains socket, check that:

- The mains power supply corresponds to the power supply indicated on the rating plate.
- The power socket and electrical circuit are adequate for the appliance.
- The power socket matches the plug. If this is not the case, have the plug replaced by a qualified electrician;
- The mains socket is adequately earthed.

Installation

Position the appliance in the room to be dehumidified.

Please follow the minimum distances between the appliance and furniture or walls, as stated in fig. 1.

Failure to do so would obstruct ventilation, jeopardising correct operation of the appliance.

When the appliance is functioning.

You should keep all doors and windows closed while the appliance is in operation.

If doors and windows are opened, the temperature and humidity in the room may change and it could therefore require longer to dehumidify the room.

With temperatures of less than 1 °C or above 40 °C, dehumidification is automatically deactivated and the appliance switches to fan only mode.

If the humidity is lower than 20%, the safety circuit triggers automatically and the dehumidifier shuts down to avoid damage.

If the humidity in the room drops, the dehumidification capacity is automatically reduced.

Do not drop or tilt the appliance.

If the appliance falls over, place it upright immediately.

Even when the room is dehumidified, condensation and mould may form externally or in poorly ventilated points, for example behind furniture.

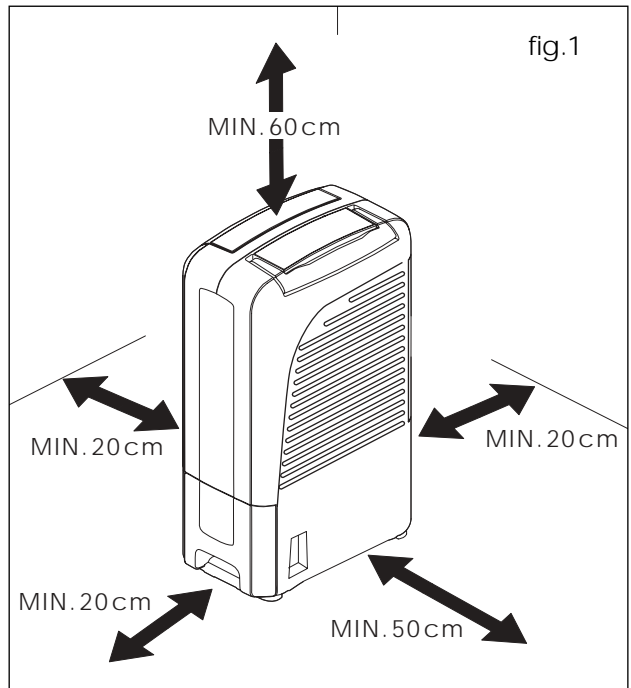

Operation

How to dehumidify

- 1) Plug the appliance into a mains socket.
- 2) Press the ON/OFF button.
 - Make sure the "tank full/tank missing" light is off. If it is on, position the tank correctly or empty it.
 - The deflector opens and the appliance comes on in automatic mode.

To turn the appliance off, press the POWER ON/OFF button.

IMPORTANT: Before unplugging from the mains, wait for the fan to stop. The fan remains in operation for about two minutes after the appliance is turned off to allow the heating element to cool down.

Selecting the operating mode

Press the dehumidification button (💧). Each time you press the (💧) button, the relative light comes on (AUTO, MIN, MAX).

Auto: to maintain a comfortable level of humidity.

Min: for silent operation.

Max: to dehumidify rapidly.

NB: The humidity level is maintained at around 55% in Auto mode and the appliance therefore comes on and goes off automatically.

(When a humidity of 55% is reached, the appliance switches into fan mode.)

How to dry laundry

Place the dehumidifier at least than 30 cm from the laundry to be dried.

NEVER place the dehumidifier under the laundry to be dried.

To dry the laundry, select the corresponding  button. You can choose between two different programmes:

ECON economy function: Use this programme during the summer. The appliance operates automatically with low energy consumption.

 **turbo mode:** use this programme to dry garments rapidly and or during the winter.

Delayed shutdown timer

Before using this function, make sure the appliance is on.

Each time the TIMER button is pressed, the number of hours the appliance operates changes (2-4-8 hours)

When the timer is set, even if the tank full light is flashing, after emptying and repositioning the tank, the appliance continues to operate for the time left.

Operation

Ioniser

Before using this function, make sure the appliance is on.

Press the  button. The light comes on and the appliance emits negative ions from the air outlet grille.

Press the  button again to interrupt negative ion emission. (The light goes off).

A large quantity of negative ions are produced, quantitatively similar to those present in environments such as forests or waterfalls.

How to direct the air

Press the **SWING** button to set automatic swing of the deflector, choosing between three types of swing:

 1st press (air is delivered forwards and vertically)

 2nd press (air is delivered forwards)

 3rd press (air is delivered vertically).

Press the **SWING** button again to stop the deflector in its current position.

Emptying the tank/ Continuous external draining

When the tank is full, the appliance stops automatically and the  tank full light lights up. Empty the tank:

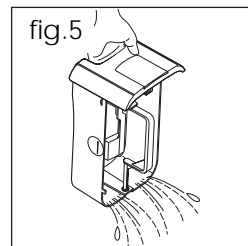
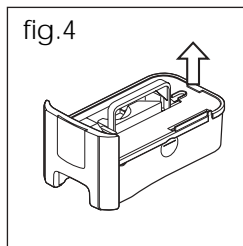
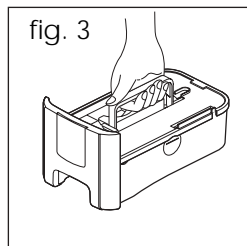
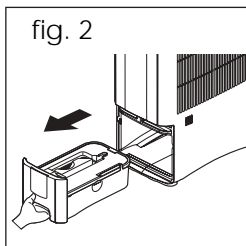

- 1 Extract the tank slowly using the designed grip, holding the appliance firmly (fig. 2).
- 2 Position the handle of the tank vertically as shown (fig. 3).
- 3 Remove the lid (fig. 4).
- 4 Empty the tank (fig. 5).
- 5 Replace the lid and lower the handle.
- 6 Put the tank back in the appliance.

When the empty tank is put back, the appliance starts functioning according to the previous settings. The tank full light goes off).

Important:

Do not remove the float inside the tank. The float is required to sense when tank is full. Replace the lid correctly before returning the tank to the appliance. When you remove the tank, do not touch internal parts of the dehumidifier. It could damage the appliance.

Push the tank into place carefully. If it knocks against the walls or is incorrectly inserted, the appliance may not function. (The tank full light flashes.) Remove the tank then replace carefully in position.

C Continuous external draining

If the appliance is to be operated for long periods but you are unable to empty the tank, it is recommended to use the continuous drain facility.

- 1) Remove the rubber bung from the outlet tube (fig. 6).
- 2) Fasten the rubber hose to the outlet tube (fig. 7).
- 3) Make sure that the hose is not higher than the outlet tube, otherwise water will remain in the tank; also check that the hose is not kinked (fig. 8).

N.B.: Keep the rubber bung. You will need it to plug the hose or close the outlet tube if you revert to draining into the tank.

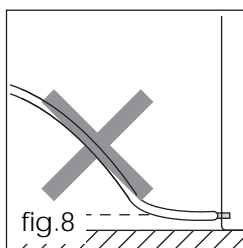
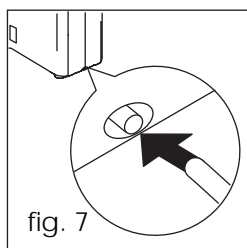
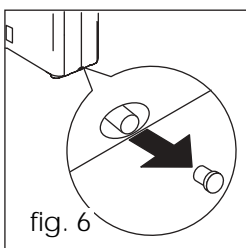

Maintenance

- Always unplug the appliance from the power socket before performing any cleaning or maintenance operations.
- Never put the machine in water or let the cord or plug get wet.

Cleaning the body

- Wipe the appliance body with a damp cloth, then dry. Don't use abrasives – they'll scratch the plastic surfaces.
- Never use alcohol or solvents to clean the appliance.

Cleaning the air filter

If the filter is dirty, air circulation is compromised and the efficiency of the dehumidifying and air purifying functions decreases.

It is therefore good practice to clean the filter at regular intervals. The frequency depends on the duration and conditions of operation.

If the unit is used regularly, you are recommended to clean the filter once a week.

Removing the filter

- Extract the filter using the handle (fig. 9).
- Use a vacuum cleaner to remove dust accumulations from the filter. **Never wash the filter in water.**

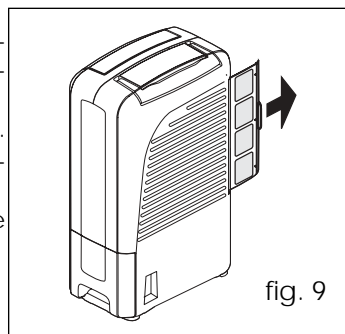

Routine cleaning of the tank (once a month)

- Extract the tank and remove the lid as described previously. **DO NOT remove the float!**
- Rinse all the components with water two or three times.
Depending on where the dehumidifier is used, the inside of the tank may become dirty as a result of dirt and dust contained in the air. If this is the case, wash in mild soapy water to remove the most stubborn dirt"

If the appliance is not used for long periods

- After having unplugged the appliance from the power socket, empty the tank.
- Clean and reposition the filter.
- Cover the appliance to protect it from dust.

Troubleshooting

Check the following points before calling the Customer Care Helpline (see guarantee leaflet)

Problems	Cause	Solution
The appliance does not work	<ul style="list-style-type: none"> • the appliance is not plugged in • there is no current • the tank is full of water • the tank is incorrectly positioned 	<ul style="list-style-type: none"> • plug into the mains • check the power supply • empty the tank • position the tank correctly
The appliance is operating in dehumidifying mode (light on), but the humidity does not decrease	<ul style="list-style-type: none"> • the filter is blocked • the temperature or humidity in the room is too low • the area is too big • too many sources of humidity in the room (pots of boiling water, etc.) • the air intake and outlet grills are blocked. 	<ul style="list-style-type: none"> • Clean the filter • in certain conditions, it is normal for the appliance not to dehumidify (in these cases the room being dehumidified should also be heated) • remove the obstructions
Alarm light on 		<ul style="list-style-type: none"> • Contact Customer Care (see guarantee leaflet)

Technical specifications

Power supply voltage
Absorbed power
Maximum power input
Absorbed current
Quantity of negative ions
Humidistat
Fan speeds
Air filter
Dimensions WxHxD
Tank capacity
Operating limits:
• temperature
• relative humidity

See rating plate
"
"
"
10000/cm ³ ca
yes
2
yes
324x187x483mm
2 litres
Dehumidifying
1° - 35°
30 - 95%