



TR88AA64C

EN User Manual | Tumble Dryer



# Welcome to AEG! Thank you for choosing our appliance.



Get usage advice, brochures, trouble shooter, service and repair information:  
[www.aeg.com/support](http://www.aeg.com/support)

Subject to change without notice.

## CONTENTS

1. SAFETY INFORMATION.....	2
2. SAFETY INSTRUCTIONS.....	5
3. PRODUCT DESCRIPTION.....	8
4. CONTROL PANEL.....	9
5.  WI-FI - CONNECTIVITY SETUP.....	11
6. PROGRAMMES.....	13
7. OPTIONS.....	17
8. BEFORE FIRST USE.....	19
9. DAILY USE.....	20
10. HINTS AND TIPS.....	24
11. CARE AND CLEANING.....	25
12. TROUBLESHOOTING.....	28
13. TECHNICAL DATA.....	30
14. <b>QUICK GUIDE</b> .....	32
15. PRODUCT INFORMATION SHEET IN REFERENCE TO E.U. REGULATION 1369/2017.....	33
16. ENVIRONMENTAL CONCERNS.....	34

## 1. SAFETY INFORMATION



Before beginning the installation and use of this appliance, carefully read the supplied instructions. The manufacturer is not responsible for any injuries or damage that are the result of incorrect installation or usage. Always keep the instructions in a safe and accessible location for future reference.



**Warning: Risk of fire / Flammable materials.**  
The appliance contains flammable gas, propane (R290), a gas with a high level of environmental compatibility. Keep fire and ignition sources away from the appliance. Be careful not to cause damage to the refrigerant circuit containing propane.

## 1.1 Children and vulnerable people safety

 **WARNING!**

Risk of suffocation, injury or permanent disability.

- This appliance can be used by children aged from 8 years and above and persons with reduced physical, sensory or mental capabilities or lack of experience and knowledge if they have been given supervision or instruction concerning the use of the appliance in a safe way and understand the hazards involved.
- Children between 3 and 8 years of age and persons with very extensive and complex disabilities shall be kept away from the appliance unless continuously supervised.
- Children of less than 3 years of age should be kept away from the appliance unless continuously supervised.
- Do not let children play with the appliance.
- Keep all packaging away from children and dispose of it appropriately.
- Keep detergents away from children.
- Keep children and pets away from the appliance when the door is open.
- If the appliance has a child safety device, it should be activated.
- Children shall not carry out cleaning and user maintenance of the appliance without supervision.

## 1.2 General Safety

- This appliance is for drying domestic-type, machine-dryable laundry only.
- Do not use the dryer function if laundry has been soiled with industrial chemicals.
- This appliance is designed for single household domestic use in an indoor environment.
- This appliance may be used in, offices, hotel guest rooms, bed & breakfast guest rooms, farm guest houses and other

similar accommodation where such use does not exceed (average) domestic usage levels.

- Do not change the specification of this appliance.
- If the tumble dryer is put on top of a washing machine, use the stacking kit. The stacking kit, available from your authorized vendor, can be used only with the appliance specified in the instructions supplied with the accessory. Read it carefully before installation (refer to the Installation leaflet).
- The appliance can be installed as freestanding or below a kitchen counter with correct space (refer to the Installation leaflet).
- Do not install the appliance behind a lockable door, a sliding door or a door with a hinge on the opposite side, that would prevent the appliance door from being fully open.
- The ventilation opening in the base must not be covered by a carpet, mat, or any floor covering.
- **WARNING:** The appliance must not be supplied through an external switching device, such as a timer, or connected to a circuit that is regularly switched on and off by a utility.
- Connect the mains plug to the mains socket only at the end of the installation process. Make sure that the mains plug is accessible after installation.
- Ensure good air ventilation in the room where the appliance is installed to avoid the backflow of unwanted gases into the room from appliances burning gas or other fuels, including open fires.
- **WARNING:** Do not install the appliance in an environment with no air exchange.  
The appliance contains flammable gas, propane (R290), a gas with a high level of environmental compatibility. Keep fire and ignition sources away from the appliance. Be careful not to cause damage to the refrigerant circuit containing propane.
- **WARNING:** In the appliance enclosure or in the built -in structure, keep ventilation opening clear of obstruction.

- **WARNING:** Do not damage the refrigerant circuit.
- If the mains power supply cable is damaged, it must be replaced by the manufacturer, its Authorised Service Centre or similarly qualified persons to avoid an electrical hazard.
- Do not exceed the maximum load of 8,0 kg (refer to the "Programme chart" chapter).
- Wipe away lint or packaging debris that has accumulated around the appliance.
- Do not run the appliance without a filter. Clean the lint filter before or after each use.
- Do not dry unwashed items in the tumble dryer.
- Items that have been soiled with substances such as cooking oil, acetone, alcohol, petrol, kerosene, spot removers, turpentine, waxes and wax removers should be washed in hot water with an extra amount of detergent before being dried in the tumble dryer.
- Items such as foam rubber (latex foam), shower caps, waterproof textiles, rubber backed articles and clothes or pillows fitted with foam rubber pads should not be dried in the tumble dryer.
- Fabric softeners, or similar products, should only be used as specified by the product manufacturer's instructions.
- Remove all objects from items that could be a source of fire ignition such as lighters or matches.
- **WARNING:** Never stop a tumble dryer before the end of the drying cycle unless all items are quickly removed and spread out so that the heat is dissipated.
- Before any maintenance operation, deactivate the appliance and disconnect the mains plug from the socket.

## 2. SAFETY INSTRUCTIONS

### 2.1 Installation



Warning: Risk of fire / Flammable materials.

- Remove all the packaging.

- Do not install or use a damaged appliance.
- Follow the installation instructions supplied with the appliance.
- Do not install the appliance in an environment with no air exchange

The appliance contains flammable gas, propane (R290), a gas with a high level of environmental compatibility. Keep fire and ignition sources away from the appliance. Be careful not to cause damage to the refrigerant circuit containing propane.

- Always take care when moving the appliance as it is heavy. Always use safety gloves and enclosed footwear.
- Do not install or use the appliance where the temperature can be lower than 5°C or higher than 35°C.
- The floor area on which the appliance is to be installed must be flat, stable, heat resistant and clean.
- Make sure that there is air circulation between the appliance and the floor.
- Always keep the appliance vertical when it is being moved.
- The rear surface of the appliance must be put against a wall.
- When the appliance is in its permanent position, check if it is levelled correctly with the aid of a spirit level. If it is not, adjust the feet accordingly.

## 2.2 Electrical connection

### **WARNING!**

Risk of fire and electric shock.

- Connect the mains plug to the mains socket only at the end of the installation. Make sure that there is access to the mains plug after the installation.
- **WARNING:** This appliance is designed to be installed / connected to a grounding connection in the building.
- Make sure that the parameters on the rating plate are compatible with the electrical ratings of the mains power supply.
- Always use a correctly installed shockproof socket.
- Do not use multi-plug adapters and extension cables.
- Do not pull the mains cable to disconnect the appliance. Always pull the mains plug.
- Do not touch the mains cable or the mains plug with wet hands.

## 2.3 Use

### **WARNING!**

Risk of injury, electric shock, fire, burns or damage to the appliance.



**Warning:** Risk of fire / Flammable materials. The appliance contains flammable gas, propane (R290), a gas with a high level of environmental compatibility. Keep fire and ignition sources away from the appliance. Be careful not to cause damage to the refrigerant circuit containing propane.

- This appliance is for household (indoors) use only.
- Do not dry damaged (torn, frayed) items that contain padding or fillings.
- If laundry has been washed with a stain remover, carry out an additional rinse cycle before starting a drying cycle.
- Dry only fabrics that are suitable to dry in the appliance. Follow the cleaning instruction on the item label.
- Do not drink or prepare food with the condensed water/distilled water. It can cause health problems to people and pets.
- Do not sit or stand on the open door of the appliance.
- Do not dry dripping wet clothes in the appliance.

## 2.4 Internal lighting

### **WARNING!**

Risk of injury.

- Visible LED radiation, do not look directly into the beam.
- To replace the internal lighting, contact the Authorised Service Centre.

## 2.5 Care and cleaning

### **WARNING!**

Risk of injury or damage to the appliance.



**Warning:** Risk of fire / Flammable materials. The appliance contains flammable gas, propane (R290), a gas with a high level

of environmental compatibility. Keep fire and ignition sources away from the appliance. Be careful not to cause damage to the refrigerant circuit containing propane.

- Do not use water spray and steam to clean the appliance.
- Clean the appliance with a moist soft cloth. Use only neutral detergents. Do not use abrasive products, abrasive cleaning pads, solvents or metal objects.
- Be careful when you clean the appliance to prevent damage to the cooling system.

## 2.6 Compressor

### **WARNING!**

Risk of damage to the appliance.

- The compressor and its system in the tumble dryer is filled with a special agent which is free from fluoro-chloro-hydrocarbons. This system must stay tight. The damage of the system can cause a leakage.

## 2.7 Service

- To repair the appliance contact the Authorised Service Centre. Use original spare parts only.
- Please note that self-repair or non-professional repair can have safety consequences and might void the guarantee.
- Concerning the lamp(s) inside this product and spare part lamps sold separately:

These lamps are intended to withstand extreme physical conditions in household appliances, such as temperature, vibration, humidity, or are intended to signal information about the operational status of the appliance. They are not intended to be used in other applications and are not suitable for household room illumination.

## 2.8 Disposal

### **WARNING!**

Risk of injury or suffocation.



Warning: Risk of fire / Risk of material damage and damage to the appliance.

- Disconnect the appliance from the mains electrical and water supplies.
- Cut off the mains electrical cable close to the appliance and dispose of it.
- The appliance contains flammable gas (R290). Contact your municipal authority for information on how to discard the appliance correctly.
- Remove the door catch to prevent children or pets from becoming trapped in the drum.
- Dispose of the appliance in accordance with local requirements for the disposal of Waste Electrical and Electronic Equipment (WEEE).

### 3. PRODUCT DESCRIPTION

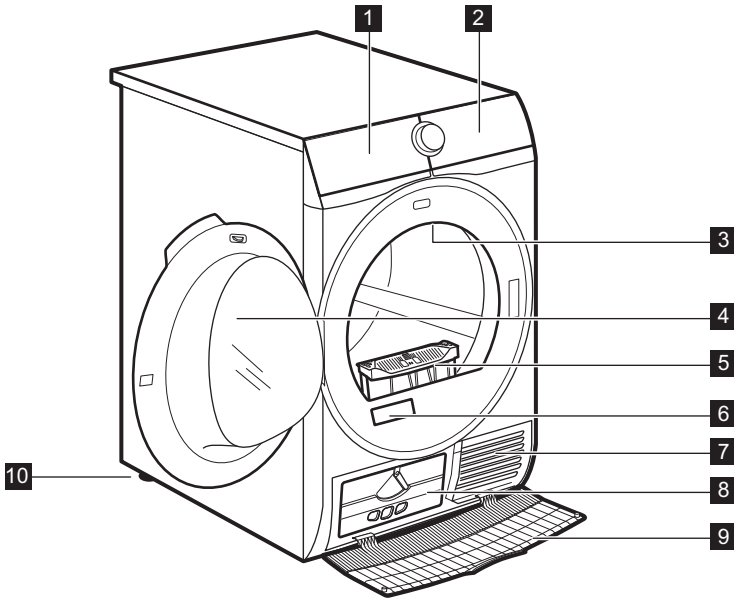

- 1 Water container
- 2 Control panel
- 3 Internal lighting
- 4 Appliance door
- 5 Filter
- 6 Rating plate and QR Code
- 7 Airflow slots
- 8 Condenser lid

- 9 Condenser cover
- 10 Adjustable feet



For ease of loading laundry or ease of installation the door is reversible (see the separate leaflet).

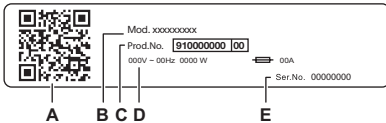



#### The rating plate reports:

- A. QR code
- B. model name
- C. product number
- D. electrical ratings
- E. serial number





Scan the **QR code** with the camera to download our App from the app store on your smart device and follow the required steps. Register your product and get the most out of it.

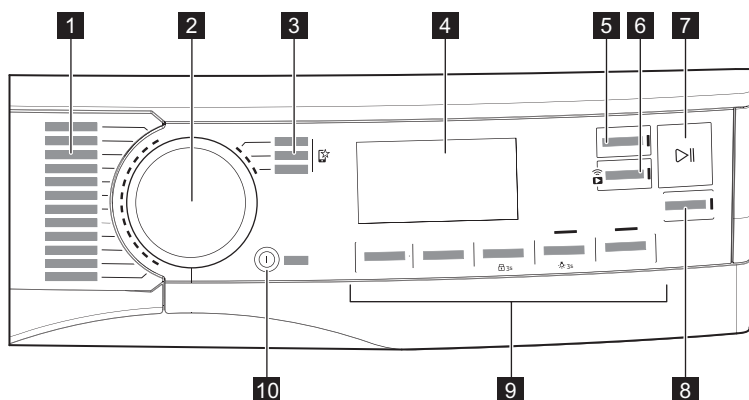

-  Access your appliance details, documentation and articles on how to use the best features (User Manual also available at [aeg.com/manuals](http://aeg.com/manuals) )
-  Get usage advice, troubleshooting, service and repair information (also available at [aeg.com/support](http://aeg.com/support) )
-  Buy accessories, Consumable and Original Spare parts for you appliance (also available at [aeg.com/shop](http://aeg.com/shop) )









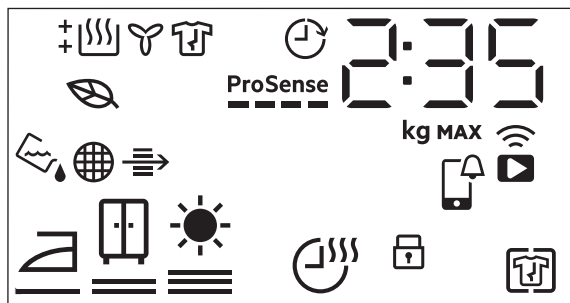



## 4. CONTROL PANEL







- |  |   |
|--|---|
| <ul style="list-style-type: none"> <li><b>1</b> Programmes</li> <li><b>2</b> Programme dial</li> <li><b>3</b> Favourite programmes </li> <li><b>4</b> Display</li> <li><b>5</b> Finish In button</li> <li><b>6</b>  Remote Start button</li> </ul> | <ul style="list-style-type: none"> <li><b>7</b>  Start/Pause button</li> <li><b>8</b>  SyncDry button</li> <li><b>9</b> Options</li> <li><b>10</b> On/Off button with <i>auto-off</i> function</li> </ul> |
|--|---|

## 4.1 Display



Symbol on the display	Symbol description
2 : 35	cycle time indication
8.0 kg MAX	maximum load
0h-24h	finish in selection (up to 24h)
	wireless connection
	remote control
	Check APP notification
	+ Anti Crease option on
	child lock on
	laundry dryness: iron dry, cupboard dry, extra dry
	Time Dry option on
	indicator: <i>drain the water container</i>
	indicator: <i>clean the filter</i>
	indicator: <i>check the condenser</i>
	<i>ECO mode drying</i>
	indicator: <i>drying phase</i>

Symbol on the display	Symbol description
	indicator: <i>cooling phase</i>
	indicator: <i>crease guard phase</i>
	Finish In option on
<b>ProSense</b> 	<b>ProSense</b> indicator
<b>MAX</b>	indicator: <i>maximum load exceeded</i>

## 5. WI-FI - CONNECTIVITY SETUP

This chapter describes how to connect the smart appliance to the Wi-Fi network and to link it to a mobile device.

By this functionality you can receive notifications, monitor and control your tumble dryer from your mobile devices.

The Wi-Fi functionality is off as factory default setting.

To connect the appliance to enjoy the full range of features and services you need:

- Wireless network at home with internet connection enabled.
- Mobile device connected to wireless network.

<b>Frequency</b>	2.412 - 2.472 GHz for European market
<b>Protocol</b>	IEEE 802.11b/g/n
<b>Max power</b>	< 20dBm
<b>Encryption</b>	WPA, WPA2, WPA3

### 5.1 QR code on rating plate

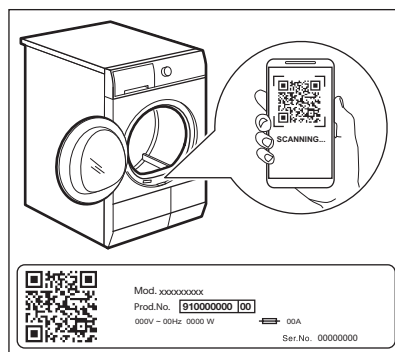

#### QR code can be used in two ways:

- Scan the QR code with the built-in camera app to download our app from the App store on your smart device and follow the required steps.
- Pairing your smart device with appliance to simplify the process. Scan the QR code with QR code scanner built-in our app.

### 5.2 Installing our app

When connecting the tumble dryer to the application, stand near it with Your smart device.

Make sure that your smart device is connected to the wireless network.





1. Go to the App Store on your smart device or scan QR code (*see chapter "QR code on rating plate"*).
2. Download and install our app.



3. Make sure you started a Wi-fi connection in the dryer. If not go to the section below.
4. Start the application. Select the country and language and login with Your email and password. If you do not have an account, create a new one following the instructions in our app.

### 5.3 Wireless connection configuration

Before you begin the configuration download and install our app on your smart device.

1. Push the On/Off button to switch on the appliance.
2. Wait approximately 8 seconds.
3. Press and hold the Remote Start button for around 3 seconds until you hear a single 'click' sound.

The symbols:  and  appear on the display. After few seconds only flashing symbol:  remains. Appliance is starting up the connection, it takes around 10 seconds for the wireless module to activate. When ready the symbol:  (**Access Point**) appears on the display. **Access Point** is open for around 3 minutes.

4. Configure our app on your smart device and follow the on screen instructions to connect the appliance to your WiFi network.
5. If the connection is established,  symbol is off and the  WiFi icon stays lit steadily.





Each time you switch the appliance on, the appliance attempts to connect to the network automatically. When the connection is established the symbol:  stops flashing.

**To switch off the wireless connection,** touch and hold down Remote Start button until you hear a single 'click' sound. The symbol: *OFF* appears on the display.



Appliance stores last connection configuration. To use wireless features of the appliance the wireless connection must be in  mode.

**To remove the wireless credentials,** touch and hold down Remote Start button for around 10 seconds until you hear 2 'beeps' sound. The symbol:    appears on the display.

### 5.4 Remote Start



Our app allows you to control your laundry through a mobile device. It contains a large number of programmes, useful features and product information tailored perfectly to the appliance. Through the app you can select the programmes already available from the appliance control panel, plus unlock additional programmes available only from a mobile device. Additional programmes can change over the time along with new versions of the app. It's personalized laundry care - all from your mobile device.

The Remote Start enables you to start a cycle in remote control.



The Remote Control activates automatically when you press the Start/ Pause button to start the program, but it is also possible to start a drying program remotely.

### Remote Start

A quick touch of this button activates the Remote Start function that allows you to start, pause and stop the appliance remotely.

The related led comes on and the related icon appears on display.



If you set a programme via App and it does not match with the knob position, **APP** text appears alternating with programme duration.

Press and hold this button for longer time to provide two other functions:

- hold it down for 3 seconds as long as a click sounds: the Wi-Fi is turned on and off.
- hold it down for 10 seconds as long as a double beep sounds and **---** appears on the display: to reset the Network Credentials.

## 5.5 Over-the-air update

### **WARNING!**

During the update it is highly recommended to not turn off or unplug the appliance.

The App may propose an update for downloading new features.

The update is accepted via App only.

If a programme is running, the App notifies that the update will start at the end of the programme.

During the update, the appliance shows **UPD** in the display.

The appliance will be usable again at the end of the update, without any notification about successful update.

If an error occurs, the appliance shows **ERR** in the display: just press any buttons or turn the knob to return to normal use.

## 5.6 Wi-Fi Always On

The Wi-Fi Always On function can be activated only via our app.

This feature keeps the appliance connected to the network even when the appliance is turned off, so that it can always be woken up and managed remotely from your device.

The indicator goes on and off intermittently (1 second on, 5 seconds off).

It is possible to turn the appliance on by pressing the On/Off button or through the App.



The Wi-Fi Always On function may affect your energy consumption. Wi-Fi Always On function is disabled by default.

# 6. PROGRAMMES

## 6.1 Our app and additional hidden programmes

Our app provides you with a **wide choice of additional hidden programmes**. Connect the appliance to the app and you will be able to choose a drying programme that suits your needs most.











You can also memorize any of the hidden cycles in the favourite programmes positions. To select the programme from the appliance directly refer to the "Favourite programmes " paragraph in "Options" section.









Programme names are subject to change depending on market requirements without notice. Our app will give you a complete description of each programme.

Sportswear Daily Training Soccer/Rugby Running Shoes Curtains	Towels Pet Hair Easy Iron Anti-Allergy Denim	Baby Linen Drying Rack
---	--	------------------------------



## 6.2 Program

Program	Load 1)	Properties / Fabric mark 2)
MixDry	5,0 kg	Designed for routine drying of what you wash without sorting. Dries evenly clothes made of cotton, cotton-synthetic blends and synthetic. / 
 3) Cottons Eco	8,0 kg	Cotton fabrics programme designed for maximum energy saving. / 
Cottons	8,0 kg	White and coloured cotton fabrics programme. Default setting is for ready to store dryness level. / 
Synthetics	4 kg	Blended garments containing mostly synthetic fibres like polyester, polyamide, etc. / 
Delicates	2,0 kg	Recommended for generic delicate fabrics such as viscose, rayon, acrylic and their blends. / 
		Gently dries for machine and hand-washable woollens. Remove immediately the items when the programme is completed.
 Wool	1,0 kg	 <b>WOOL HAND WASH SAFE</b>
		The wool drying cycle of this machine has been approved by The Woolmark Company for the drying of wool garments labelled as "hand wash" provided that the garments are dried according to the instructions issued by the manufacturer of this machine. Follow the garment care label for other laundry instructions. M2001 The Woolmark symbol is a Certification mark in many countries.
Silk	0,5 kg	Preserves the shape of delicate machine and hand-washable silk clothes, minimizing creases by using gentle warm air and soft movements. / 
Bedlinen XL	4,5 kg	Dries up to three bed linen sets at once. Minimises twists and tangles of large items to ensure every bed linen reaches a uniform dryness without wet spots. / 

Program	Load 1)	Properties / Fabric mark 2)
 Outdoor	2,0 kg	Maintains the functionality of outdoor fabrics made of technical textile and restores water repellency on waterproof jackets and shell jackets with removable linings (suitable for drying in tumble dryer). / 
 Hygiene	5,0 kg	Dries and sanitizes your garments and other items maintaining the temperature above 60°C over time, removing 99.9% of bacteria and viruses <sup>4)</sup> . Note: This cycle should only be used for wet items. Not suitable for delicate items. / 
Duvet	3,0 kg	Ensures proper drying of inner parts through single or double duvets, pillows, and padded blankets. / 
Refresh	1,0 kg	<b>For dry clothes only</b> Short low temperature cycle that helps in removing odours from a small amount of garments. Indicated also for dry clothes that were in storage for long time. / 













1) The maximum weight refers to dry items.









2) For fabric mark meaning see chapter *DAILY USE: Preparing the laundry*.

3) The  Cottons ECO programme in combination with the *cupboard dry*  Dryness Level selection is the "Standard cotton programme" according to Commission Regulation EU No. 392/2012. It is suitable for drying normal wet cotton laundry and it is the most efficient programme in terms of energy consumption for drying wet cotton laundry.

4) Tested for *Candida albicans*, MS2 Bacteriophage and *Escherichia coli* in external test performed by Swisstat Testmaterialien AG in 2021 (Test Report No. 20212038).

## Program and options selection compatibility

Program 1)	Options			
	Dryness Level	Time Dry	+ Anti Crease	Silent
MixDry	 	■	■	■
 Cottons Eco	 		■	
Cottons	 	■	■	■
Synthetics	 	■	■	■
Delicates	 2)		■	
  Wool		■ 3)		

Options				
Program 1)	Dryness Level	Time Dry	+ Anti Crease	Silent
Silk	 2)		■	
Bedlinen XL	  	■	■	
 Outdoor	 2)		■	
 Hygiene	 2)		■	
Duvet	 2)		■	
Refresh			■	

1) Aside from the programme, you can set one or more options at the same time.



2) Set by default

3) See chapter OPTIONS: Time Dry on Wool programme

## Consumption data



Following values are obtained in laboratory conditions according with relevant standards. Different parameters can change the data, for example: the quantity of laundry, the type of laundry and the ambient conditions. The initial moisture content of the laundry, the water type, the supply voltage and if you change the default setting of a programme may also affect the energy use, the duration of the drying programme and final humidity.

Program	Spun at / residual humidity	Drying time 1)	Energy consumption 2)
Cottons <b>Eco</b> 8,0 kg			
 <i>cupboardDry</i>	1400 rpm / 50%	150 min	1,25 kWh
	1000 rpm / 60%	175 min	1,49 kWh
Cottons 8,0 kg			
 <i>Iron Dry</i>	1400 rpm / 50%	110 min	0,85 kWh
	1000 rpm / 60%	125 min	1,05 kWh
Cottons <b>Eco</b> 4,0 kg			
 <i>cupboardDry</i>	1400 rpm / 50%	90 min	0,70 kWh
	1000 rpm / 60%	105 min	0,81 kWh
Synthetics 4 kg			



Program	Spun at / residual humidity	Drying time 1)	Energy consumption 2)
 cupboardDry	1200 rpm / 40%	71 min	0,51 kWh
	800 rpm / 50%	87 min	0,65 kWh



1) For partial loads, the cycle time is shorter and appliance uses less energy.



2) Improper ambient temperature and/or poorly centrifuged laundry can prolong cycle time and increase the energy consumption.



## 7. OPTIONS

### 7.1 Dryness Level

This option helps to achieve requested laundry dryness. You can select the level of dryness:

 =  ready to iron - **iron dry** level

 =  ready to store - **cupboard dry** level<sup>1)</sup>

 =  ready to store - **extra dry** level

1) Default selection which is related to the programme

### 7.2 Time Dry

For: Cottons, Bedlinen **XL**, Synthetics and MixDry programs. Lets the user to set drying time from minimum 10 min to maximum of 2 hours (in 10 min steps). When this option is maximum, load indicator disappears.



The cycle lasts as long as set drying time regardless of the size of a load and its dryness.

#### TIME DRYING RECOMMENDATION

up 10 min	action of cool air only (no heater).
10 - 40 min	additional drying to improve dryness after previous drying cycle.
> 40 min	full drying of the small laundry loads up to 4 kg, well spun (>1200 rpm).

### Time Dry on Wool program

Option applicable to Wool program to adjust final dryness level to more dry or less dry.

### 7.3 + Anti Crease

Extends up to 120 minutes the anti-crease phase (30 minutes) at the end of the drying cycle. After drying phase drum rotates from time to time to prevent creases. Laundry can be removed during the anti-crease phase.

### 7.4 Silent

The appliance operates with low noise without effect on the drying quality. The appliance operates slowly with longer cycle time.

### 7.5 End Signal

The acoustic signal sounds at the following:

- cycle end
  - start and end of crease guard phase
- The acoustic signal is by default always on. You can use this option to activate or deactivate the sound.

### 7.6 Finish In



This option allows choosing the time at which a programme should terminate. Once activated the machine waits for the right moment to begin the drying process.

Finish In time is the sum of stand by time and drying time.

To set the Finish In option:

1. Set the drying programme and options.
2. Touch Finish In repeatedly until the display shows the desired time within the programme should end (e.g. 12h if the programme has to finish within 12 hours.)
3. Touch the Start/Pause button. The drum starts rotating to perform the **ProSense** estimation, if foreseen in the selected programme.
4. The appliance starts the countdown to the end of the programme and the programme will start at the right moment for ending.

## 7.7 Favourite programmes

These selector positions are available after the appliance have been connected to Wi-Fi.

The favourite programmes can be set and saved via App only choosing from the available ones which are divided into the three categories indicated on the control panel.

Once the favourite programmes have been set, you can select one of them via App or by turning the programme dial to relevant position: the relevant led comes on and the information on the display are updated accordingly.



The favourite programmes can be cancelled through the related App command or pressing the Factory Default key combination.

## 7.8 Remote Start

A quick touch of this button activates the Remote Start function that allows you to start, pause and stop the appliance remotely.

The related led comes on and the related icon appears on display.



If you set a programme via App and it does not match with the knob position, **APP** text appears alternating with programme duration.

Press and hold this button for longer time to provide two other functions:

- hold it down for 3 seconds as long as a click sounds: the Wi-Fi is turned on and off.
- hold it down for 10 seconds as long as a double beep sounds and **---** appears on the display: to reset the Network Credentials.

## 7.9 SyncDry function

This feature lets your tumble dryer to automatically set the most appropriate programme that matches the last washing program recently executed. All you need to do is start the drying programme once your tumble dryer is loaded. No other programme settings or options are required on the tumble dryer.

Once the washing programme has come to an end, the washing machine transfers the programme data via the home router Wi-Fi to the AEG Cloud, as well as to your tumble dryer.



In order to use the SyncDry function, the AEG tumble dryer and washing machine must be connected to the same home network and paired with our app.

To activate the function:

1. Once the wash cycle has come to an end, place the clean laundry in the tumble dryer.
2. Touch **SyncDry** button.
3. All display symbols will stay lighted off except **Wi-Fi** icon and **ProSense** bars that run an animation for a few seconds as the appliance is retrieving data from the cloud.
4. Display will update itself automatically with the suggested programme. After 10 seconds, if data retrieving is

unsuccessful, the button LED is switched off and the machine gives an acoustic error signal. Then previously selected programme is restored.

5. Touch **Start/Pause** button to begin drying process.



When **SyncDry** programme is set, user is still allowed to change options or select another program by rotating knob or using APP. In such cases **SyncDry** button LED will turn off to indicate that the program is not anymore the suggested one; **SyncDry** automatic program can be selected again by pressing related button until data is available on Cloud.

## 8. BEFORE FIRST USE



Rear drum locks are removed automatically when dryer is activated for the first time. Possible to hear some noise.

### To unlock the rear drum locks:

1. Switch on the appliance.
  2. Set any programme.
  3. Press the Start/Pause button.
- Drum starts to rotate. Rear drum locks are automatically deactivated.

### Before you use the appliance to dry items:

- Clean the tumble dryer drum with a moist cloth.
- Start a 1 hour programme with moist laundry.



At the beginning of the drying cycle (first 3-5 min) there could be a slightly higher sound level. This is due to the compressor starting up. This is normal for compressor powered appliances such as refrigerators and freezers.

### 8.1 Unusual smell

The appliance is tightly packed.

After product unpacking you can feel an unusual smell. This is normal for brand new products.

Appliance is built of several different types of material which all together can generate unusual smell.

Over usage time, after few drying cycles unusual smell gradually disappears.

### 8.2 Noises



Different noises may be heard at different times during the drying cycle. They are perfectly normal operating sounds.

#### Working compressor.

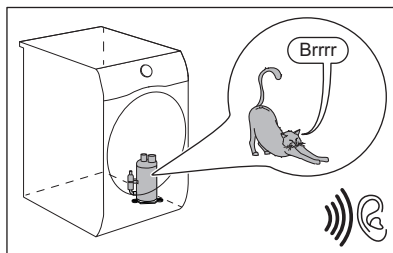

#### Rotating drum.

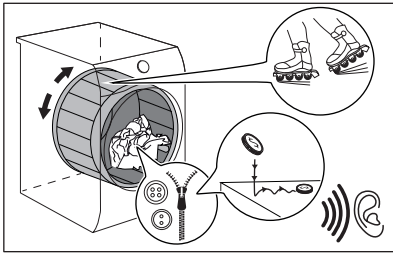

**Working fans.**

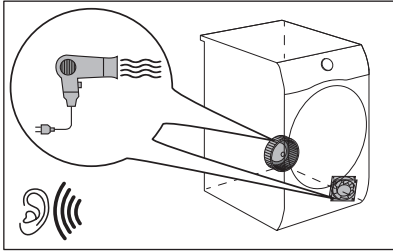

**Working pump and transferring condensation to the tank.**

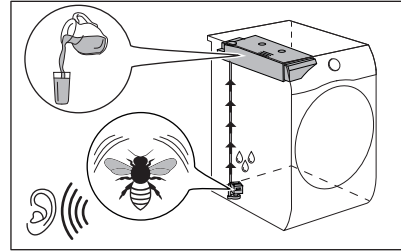

## 9. DAILY USE

### 9.1 Preparing the laundry



Loading the drum up to the maximum capacity indicated for the respective programmes will contribute to the energy saving.







Very often the clothes after washing cycle are kneaded and tangled altogether. Drying kneaded and tangled clothes is inefficient. To assure proper air flow and even drying it is recommended to shake and load one by one the clothes to the tumble dryer.

To assure proper drying process:

- Close the zips.
- Close the fasteners of duvet covers.
- Do not dry ties or ribbons loose (e.g. apron ribbons). Tie them before you start a programme.

- Remove all items from pockets.
- Turn items with the internal layer made of cotton inside out. Cotton layer must be faced outwards.
- Always set the programme suitable for the type of laundry.
- Do not put light and dark colours together.
- Use suitable programme for cottons, jersey and knitwear to reduce shrinkage.
- Do not exceed the maximum load stated in the programmes chapter or shown on the display.
- Dry only the laundry that is suitable for tumble drying. Refer to the fabric label on the items.
- Do not dry large and small items together. Small items can be trapped inside the large items and remain wet.
- Shake the large clothes, fabrics before placing in the tumble dryer. It is to avoid moist places inside the fabric after the drying cycle.

Fabric label	Description
	Laundry is suitable for tumble drying.
	Laundry is suitable for tumble drying at higher temperatures.
	Laundry is suitable for tumble drying at low temperatures only.
	Laundry is not suitable for tumble drying.

## 9.2 To achieve best drying results

- The selected programme must be adequate to the type of dried clothes.
- The filter must be clean. Clogged filter makes drying inefficient.
- It is recommended to shake items before loading. Loose items are more liable for drying.
- The recommended load of dried items must be respected.
- The airflow slots must be clean.

## 9.3 Loading the laundry

### CAUTION!

Ensure the laundry is not trapped between the appliance door and the rubber seal.

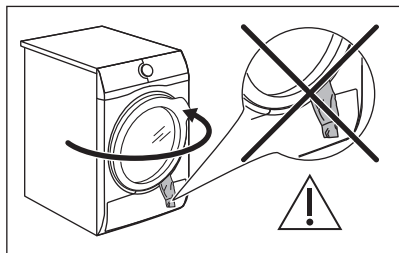

1. Pull open the appliance door.
2. Load the laundry one item at a time.
3. Close the appliance door.

## 9.4 Turning on the appliance

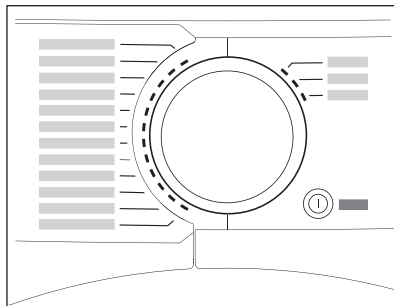

To turn on the appliance:

Push the On/Off button.

If the appliance is on, some indicators appear on the display.

## 9.5 auto-off function

To decrease the energy consumption, the auto-off function turns the appliance off automatically:

- if the Start/Pause touch button is not touched within 5 minutes.
- 5 minutes after a cycle ends.

Push the On/Off button to turn on the appliance.

If the appliance is on, some indications appear on the display.

## 9.6 Setting a programme

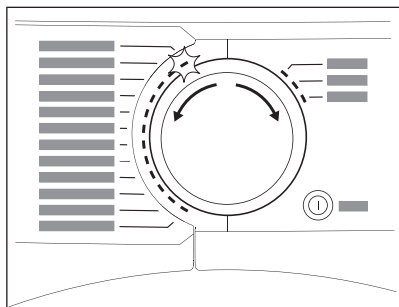

Use the programme dial to set the programme.  
The approximate programme duration appears on the display.



Real drying time will depend on type of the load (quantity and composition), the room temperature and the initial moisture of your laundry after spinning phase.

## 9.7 Options

Together with the programme you can set 1 or more options.

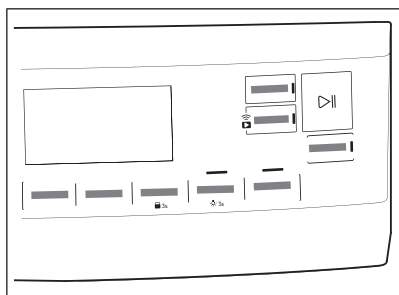

To activate or deactivate an option touch the relevant button.  
its symbol appears on the display or the led above the corresponding button lights up.

## 9.8 Child lock option

The child lock can be set to prevent children from playing with the appliance. The child lock option locks all touch buttons and the program dial (this option does not lock the **On/Off** button).

You can activate the child lock option:

- before you touch the **Start/Pause** button - the appliance cannot start
- after you touch the **Start/Pause** button - programs and option selection is unavailable.

Child lock option activation:

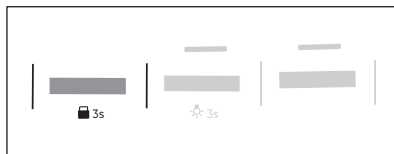

1. Turn the dryer on.
2. Select 1 of the available programs.
3. Touch and hold down **+ Anti Crease** button by around 3 seconds.

The symbol  appears on the display.

4. To deactivate the child lock, touch the above button again until the symbol disappears.

## 9.9 Starting a program

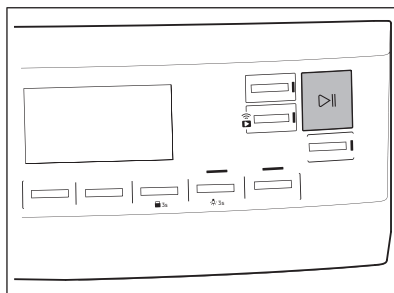

To start the program:

Touch the **Start/Pause** button.  
The appliance starts and the LED above the button stops flashing and stays on.

## 9.10 The ProSense load detection



The **ProSense** The ProSense technology detects the laundry load size defining the programme duration.

After setting a drying programme, the **ProSense** icon lights up on the display if the programme supports it.

Touching the Start/Pause button, the ProSense starts the laundry load detection:

1. The appliance detects the load in the first minute: the indicator flashes, the bars under the icon move back and forth  and the drum rotates shortly.
2. When the drum stops rotating, the display shows the new programme duration adjusted according to the detected load. The number of bars, from 1 to 4, represents the estimated load amount. 4 bars represent the maximum load amount for the selected programme.



In case of **drum overload**, the maximum declared load indicator comes on again

with the **MAX** indicator blinking. In this case, during these 30 seconds, it is possible to open the door and remove the exceeding garments. Once removed, touch the Start/Pause button to start the programme again. If the laundry amount will not be reduced, the programme starts anyway. In this case, it will be not possible to guarantee the best results.

## 9.11 Program change

To change a program:

1. Push the On/Off button to turn the appliance off.
2. Push the On/Off button again to turn on the appliance.
3. Set a new program.

## 9.12 Programme end



Clean the filter and drain the water container after each drying cycle. (See chapter CARE AND CLEANING.)

If the drying cycle is finished, the symbol  appears on the display. If the End Signal option is activated, the acoustic signal sounds intermittently for 1 minute.



If you do not turn off the appliance, the anti-crease phase starts (not active with all programmes). Flashing  symbol signals the execution of the anti-crease phase. Laundry can be removed during this phase.

To remove the laundry:

1. Push the On/Off button for 2 seconds to turn the appliance off.
2. Open the appliance door.
3. Remove the laundry.
4. Close the appliance door.

Possible causes of unsatisfactory drying results:

- Inadequate default dryness level settings. See chapter *Adjustment of the target final moisture*
- Room temperature is too low or too high. Optimal room temperature is between 18°-25°C.



Leave the door slightly opened after every cycle to avoid moisture.

## 9.13 Drum light on

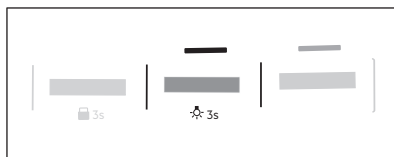

Touch and hold down **Silent** button by around 3 seconds.  
The light inside the drum is on.

## 10. HINTS AND TIPS

### 10.1 Ecological hints



Loading the drum up to the maximum capacity indicated for the respective programmes will contribute to the energy saving.

- Spin the laundry well before drying.
- Do not exceed the load sizes which are specified in the programmes chapter.
- Clean the filter after each drying cycle.
- Do not use fabric softener to wash and then dry. In the tumble dryer laundry becomes soft automatically.
- The water from the water container can be used to iron the clothes. You must first filter the water to eliminate remaining textile fibres (simple coffee filter is suitable).
- Always keep the airflow slots at the bottom of the appliance clear.
- Make sure there is good airflow where the appliance is to be installed.

### 10.2 Adjustment of default dryness level

To change the default dryness level:

1. Turn the appliance on.
2. Select 1 of the available programmes.
3. Touch and hold down the **Time Dry** and **+ Anti Crease** buttons at the same time.

One of the symbols appears on the display:

- Maximum dryness

- Extra dryness

- Standard dryness

4. Touch the **Start/Pause** button repeatedly until you reach the desired dryness level.

Dryness level	Display symbol
Maximum dryness	+
Extra dryness	+

Dryness level	Display symbol
---------------	----------------

Standard dryness



5. To memorise the setting touch and hold down the **Time Dry** and **+ Anti Crease** buttons at the same time for approximately 2 seconds.



In case of Wi-Fi network connected machines a **ProSense** bars animation is performed for a few seconds to indicate that your appliance is updating data to the Cloud.

If instead the mode is changed with knob rotation or switching off the machine, the data synchronization will be done during the first Wi-Fi reconnection.

### 10.3 Deactivating the water container indicator

*The water container indicator is activated by default. It illuminates at the end of the drying cycle or during the cycle if the water reservoir is full. If the draining kit is installed the water container is drained automatically and the indicator can be deactivated.*

To deactivate the indicator:

1. Turn the appliance on.
2. Select 1 of the available programmes.
3. Touch and hold down **Silent** and **End Signal** buttons at the same time.

The water container indicator: is off and the symbol appears - the water container indicator is permanently **deactivated**



To activate the water container indicator back, follow the above procedure again.

The water container indicator: is on and the symbol appears - the water container indicator is permanently **activated**



## 10.4 Operating hours counter

This function gives a possibility to display the total operating time of the appliance in hours, which is counted from the moment it is first switched on. The actual operating time of the cycles is shown (does not include pauses or delayed start time).

To visualise this value, proceed as follows:

1. Switch the appliance on by pressing the **On/Off** button.
2. Press and hold the **Time Dry** and **Dryness Level** buttons for some seconds.
3. After 3 seconds the total hours operated by the appliance are shown in the display: e.g. if the operating time is **1276** hours, the display shows the text **Hr** for 2 seconds then **12** for 2 seconds followed by **76**. This value is displayed with a sequence of two digits at a time: the first two digits indicate thousands and hundreds, the second two digits indicate tens and units.

To exit this mode, either press any button, turn the selector knob or switch the appliance off.

## 10.5 Factory Defaults

This function allows to restore the factory default settings. The saved options and working modes will be reset. It will also remove WiFi network credentials from the appliance memory and reset personalized program settings.

To **activate** this option follow steps below:

1. Switch the appliance on by pressing **On/Off** button.
2. Wait approximately 8 seconds.
3. Press and hold the **Silent** and **+ Anti Crease** buttons for some seconds.
4. The appliance will acknowledge the operation by displaying **-- --**.



If the procedure does not work (this could be due to timeout or wrong keys combination), switch the appliance off and repeat the sequence from the beginning.

# 11. CARE AND CLEANING

## 11.1 Cleaning the filter

At the end of each cycle the  *Filter* symbol comes on the display and you must clean the filter.



The filter collects the lint during the drying cycle.



To achieve the best drying performance clean the filter regularly. The clogged filter causes the longer drying cycle and as a consequence the energy consumption increase. Clean the filter by hand. Use a vacuum cleaner if necessary.

### CAUTION!

When cleaning the filters, the lint should be thrown in the garbage bin and not washed through the drain in order to avoid spreading microplastics in the used water system.

1. Open the door. Pull the filter up.

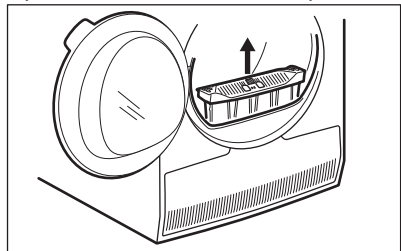

2. Push the hook to open the filter.

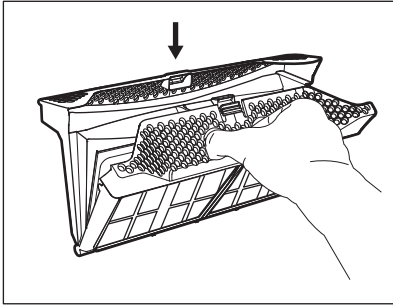

3. Gather lint with hand from both internal parts of the filter.

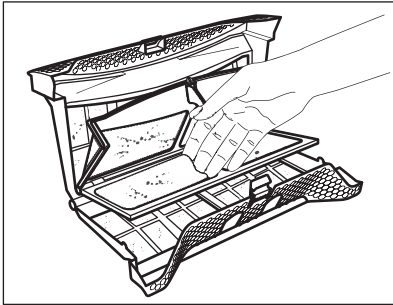

Throw the lint in the dustbin.

4. If necessary, clean the filter with a vacuum cleaner. Close the filter.
5. If necessary, remove lint from the filter socket and gasket. You can use a vacuum cleaner. Place the filter back inside the filter socket.

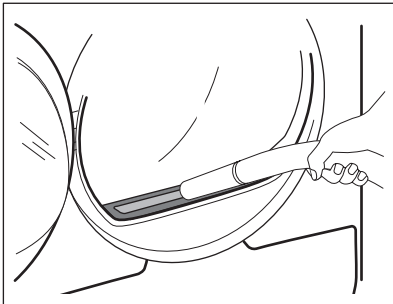

## 11.2 Emptying the water container

Empty the condensed water container after each drying cycle.

If the condensed water container is full, the programme stops automatically. The  *Water container* symbol comes on the display and you must empty the water container.

To empty the water container:

1. Pull the water container out keeping it in a horizontal position.

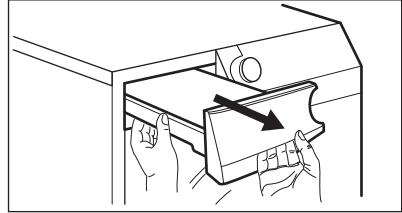

2. Pull the plastic connection out and drain the water into a basin or equivalent receptacle.

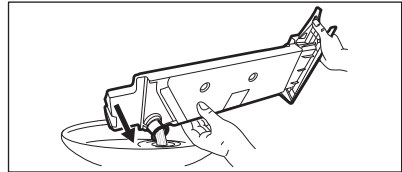

3. Push the plastic connection back in and place the water container back into position.
4. To continue the programme press the Start/Pause button.

## 11.3 Cleaning the condenser

If the symbol  *Heat exchanger* flashes on the display, inspect the condenser and its compartment. If it is dirty, clean it. Do the check not less than once a 6 months.

### **WARNING!**

Do not touch the metal surface with bare hands. Risk of injury. Wear protective gloves. Clean carefully to avoid damaging the metal surface.

To inspect:

1. Open the door. Pull the filter up.

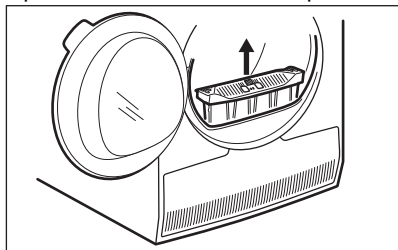

2. Open the condenser cover.

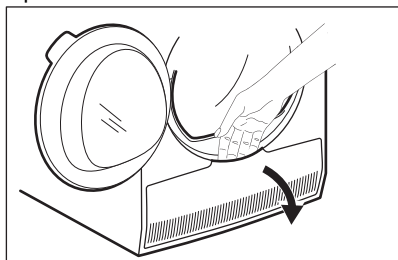

3. Turn the lever to unlock the condenser lid.

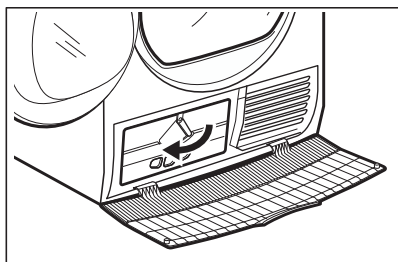

4. Lower the condenser lid.

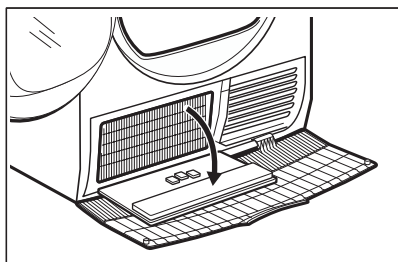

5. If necessary, remove the fluff from the condenser and its compartment. You can use a vacuum cleaner with the brush

attachment.

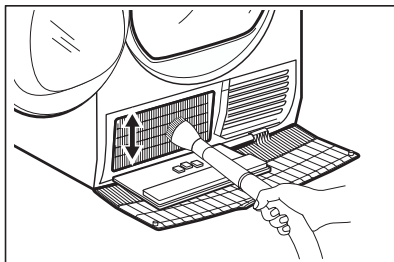

6. Close the condenser lid.
7. Turn the lever until it clicks into position.
8. Put the filter back.

## 11.4 Cleaning the drum

### **WARNING!**

Disconnect the appliance before you clean it.

Use a standard neutral soap detergent to clean the inner surface of the drum and drum lifters. Dry the cleaned surfaces with a soft cloth.

### **CAUTION!**

Do not use abrasive materials or steel wool to clean the drum.

## 11.5 Cleaning the control panel and housing

Use a standard neutral soap detergent to clean the control panel and housing.

Use a moist cloth to clean. Dry the cleaned surfaces with a soft cloth.

### **CAUTION!**

Do not use furniture cleaning agents or cleaning agents which can cause corrosion.

## 11.6 Cleaning the airflow slots

Use a vacuum cleaner to remove fluff from the airflow slots.

## 12. TROUBLESHOOTING

### **WARNING!**

Refer to Safety chapters.

### 12.1 Error Codes

The appliance does not start or it stops during operation.

First try to find a solution to the problem (refer to the table). If the problem persists, contact the Authorised Service Centre.

### **WARNING!**

Deactivate the appliance before carrying out any check.

**In case of major problems, the acoustic signals operate, the display shows an error code and the Start/Pause button may flash continuously:**



Error code	Possible cause	Remedy
E50	Appliance motor overloaded. Too much laundry or entrapped in the drum.	The programme was not completed. Remove the laundry from the drum, set the programme and restart the cycle.
E90 or E91	Internal fail. No communication between electronic elements of the appliance.	The programme was not finished properly or the appliance stopped too early. Switch the appliance off and on again. If the error code appears again, contact the Authorised Service Centre.
EH0	The mains supply is unstable.	When the appliance is showing <b>EH0</b> , please wait until main supply is stable than press start. If the appliance paused the cycle without any indication then press the cycle start. If the warning will occur again check the power cord / socket integrity or main supply.

If the display shows other error codes, deactivate and activate the appliance. If the problem continues, contact the Authorised Service Centre.

In case of different problem with the tumble dryer check the table below for possible solutions.

### 12.2 Troubleshooting

Problem	Possible cause	Remedy
The tumble dryer does not operate.	The tumble dryer is not connected to the mains supply.	Connect it to the mains socket. Check the fuse in the fuse box (domestic installation).
	The door is open.	Close the door.
	The On/Off button was not pushed.	Push the On/Off button.
	The Start/Pause button was not touched.	Touch the Start/Pause button.
	The appliance is in standby mode.	Push the On/Off button.

Problem	Possible cause	Remedy
Unsatisfactory drying result.	Incorrect program selection.	Select a suitable program. <b>1)</b>
	The filter is clogged.	Clean the filter. <b>2)</b>
	Dryness Level option was set to  <b>3)</b>	Change Dryness Level option to a higher level.
	The load was too large.	Do not exceed the maximum load size.
	The airflow slots are clogged.	Clean the airflow slots at the bottom of the appliance.
	There is some dirt on the humidity sensor in the drum.	Clean the front surface of the drum.
	The dryness level was not set to the desired level.	Adjust the dryness level. <b>4)</b>
	The condenser is clogged.	Clean the condenser. <b>2)</b>
The loading door does not close	The filter is not locked into position.	Put the filter in the correct position.
	Laundry is trapped between the door and the seal.	Remove trapped items and close the door.
It is not possible to change the program or option.	After a cycle starts it is not possible to change the program or option.	Turn the tumble dryer off and on. Change the program or option as required.
It is not possible to select an option. An acoustic signal is emitted.	The option you tried to select is not available for the selected program.	Turn the tumble dryer off and on. Change the program or option as required.
There is no drum light	Defective drum lamp.	Contact the service centre to replace the drum lamp.
Unexpected duration time appears on the display.	The drying duration is calculated according to load size and dampness.	This is automated - the appliance is working correctly.
A program is inactive.	The water container is full.	Drain the water container, push the Start/Pause button. <b>2)</b>
The drying cycle is too short.	The load size is small.	Select a time program. The time value must be related to the load. To dry one item or a small amount of laundry we recommend short drying times.
	The laundry is too dry.	Select an appropriate time program or a higher dryness level (e.g.  <i>extra dry</i> )

Problem	Possible cause	Remedy
Drying cycle too long <b>5)</b>	The filter is clogged.	Clean the filter.
	The load is too large.	Do not exceed the maximum load size.
	The laundry was not spun sufficiently.	Spin the laundry well in the washing machine.
	Too low or too high room temperature - this is not the appliance malfunction.	Ensure a room temperature higher than +5°C and lower than +35°C. Optimal room temperature to achieve best drying results is between 18°-25°C.
The display shows: 	All buttons are inactive, except the Start/Pause.	The appliance downloads the APP updates. Wait until the update process is complete. If you deactivate the appliance during update, it resumes when you activate the appliance again.
No wireless connection or connection often brakes off.	The wireless home network does not work.	Check wireless home network configuration. Restart the router. If problem still exists contact your wireless service provider.
	The smart device or the appliance or both are not paired with the wireless network.	Repeat connection configuration steps on smart device or the appliance or both.
The connection with the appliance through our app does not work frequently.	Poor or missing connection between the tumble dryer and router.	Assure proper connection between the appliance and the home router. Move the router closer to the appliance. Equip your home network with wireless range extender. Do not use at the same time microwave oven and remote control. The microwave oven can disrupt the connection signal.

- 1) Follow the program description — see the PROGRAMS chapter .
- 2) See the *CARE AND CLEANING* chapter.
- 3) Only dryers with the Dryness Level option.
- 4) See the HINTS AND TIPS chapter .
- 5) Note: After a maximum of 6 hours the drying cycle ends automatically.

### 12.3 Possible causes of unsatisfactory drying results:

- The filter is clogged. Clogged filter makes drying inefficient.
- The airflow slots are clogged.
- The humidity sensor is dirty.
- The drum is dirty.

- Inadequate default dryness level settings. See chapter *Adjustment of default dryness level*
- Room temperature is too low or too high. Optimal room temperature is between 18°-25°C.

## 13. TECHNICAL DATA

Height x Width x Depth	850 x 596 x 638 mm (maximal 663 mm)
Max. depth with the appliance door open	1108 mm
Max. width with the appliance door open	958 mm

Adjustable height	850 mm (+ 15 mm - feet regulation)
Drum volume	118 l
Maximum load volume	<b>8,0 kg</b>
Voltage	230 V
Frequency	50 Hz
Sound power level	65 dB
Total power	700 W
Energy efficiency class	<b>A+++</b>
Energy consumption on the standard cotton programme with the full load. <b>1)</b>	<b>1,49 kWh</b>
Energy consumption on the standard cotton programme with the partial load. <b>2)</b>	<b>0,81 kWh</b>
Annual energy consumption <sup>3)</sup>	176,50 kWh
Left-on mode power absorption <b>4)</b>	0,05 W
Off mode power absorption <b>4)</b>	0,05 W
Power consumption in networked standby <sup>5)4)</sup>	2,0 W
Time to networked standby <sup>4)</sup>	15 min.
Type of use	Household
Allowed ambient temperature	+ 5°C to + 35°C
Level of protection against ingress of solid particles and moisture ensured by the protective cover, except where the low voltage equipment has no protection against moisture	<b>IPX4</b>
Gas designation	R290
Weight	0,149 kg

**1)** With reference to EN 61121. 8,0 kg of cotton centrifuged at 1000 rpm.

**2)** With reference to EN 61121. 4,0 kg of cotton centrifuged at 1000 rpm.

**3)** Energy consumption per year in kWh, based on 160 drying cycles of the standard cotton programme at full and partial load, and the consumption of the low-power modes. Actual energy consumption per cycle will depend on how the appliance is used (REGULATION (EU) No. 392/2012).

**4)** With reference to EN 61121.

**5)** The energy consumption of the connected function is approximately 17,5 kWh per year. To disconnect this function, please refer to the chapter "Wi-fi - Connectivity setup".

The information given in the chart above is compliant with the EU Commission regulation 392/2012 implementing directive 2009/125/EC.

## 14. QUICK GUIDE

### 14.1 Daily use

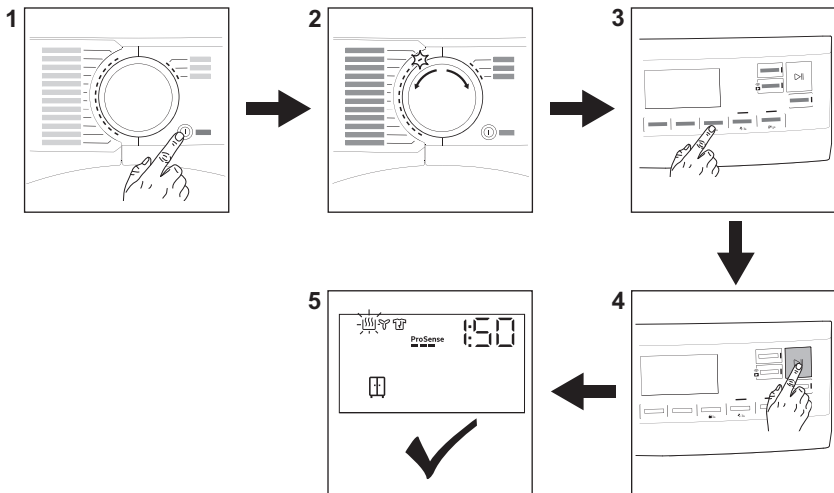

1. Push the **On/Off** button to turn on the appliance.
2. Use the programme dial to set the programme.
3. To activate or deactivate an option touch the relevant button or 2 buttons combination.
4. Touch the **Start/Pause** button.
5. The appliance starts.

### 14.2 Cleaning the filter

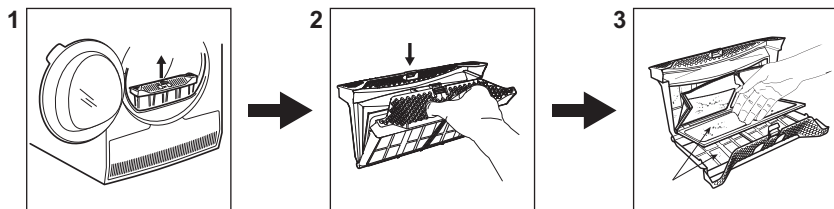







At the end of each cycle the  *Filter* symbol comes on the display and you must clean the filter.

1. Open the door. Pull the filter up.
2. Push the hook to open the filter.

3. Gather lint with hand from both internal parts of the filter. Throw the lint in the dustbin.



## 14.3 Program

Program	Load <sup>1)</sup>	Properties / Fabric mark 
MixDry	5,0 kg	Designed for routine drying of what you wash without sorting. Dries evenly clothes made of cotton, cotton-synthetic blends and synthetic.
 Cottons Eco	8,0 kg	Cotton fabrics programme designed for maximum energy saving.
Cottons	8,0 kg	White and coloured cotton fabrics programme. Default setting is for ready to store dryness level.
Synthetics	4 kg	Blended garments containing mostly synthetic fibres like polyester, polyamide, etc.
Delicates	2,0 kg	Recommended for generic delicate fabrics such as viscose, rayon, acrylic and their blends.
  Wool	1,0 kg	Gently dries for machine and hand-washable woollens. Remove immediately the items when the programme is completed.
Silk	0,5 kg	Preserves the shape of delicate machine and hand-washable silk clothes, minimizing creases by using gentle warm air and soft movements.
Bedlinen XL	4,5 kg	Dries up to three bed linen sets at once. Minimises twists and tangles of large items to ensure every bed linen reaches a uniform dryness without wet spots.
 Outdoor	2,0 kg	Maintains the functionality of outdoor fabrics made of technical textile and restores water repellency on waterproof jackets and shell jackets with removable linings (suitable for drying in tumble dryer).
 Hygiene	5,0 kg	Dries and sanitizes your garments and other items maintaining the temperature above 60°C over time, removing 99.9% of bacteria and viruses <sup>2)</sup> . Note: This cycle should only be used for wet items. Not suitable for delicate items.
Duvet	3,0 kg	Ensures proper drying of inner parts through single or double duvets, pillows, and padded blankets.
Refresh	1,0 kg	<b>For dry clothes only</b> Short low temperature cycle that helps in removing odours from a small amount of garments. Indicated also for dry clothes that were in storage for long time.

1) The maximum weight refers to dry items.

2) Tested for Candida albicans, MS2 Bacteriophage and Escherichia coli in external test performed by Swissatest Testmaterialien AG in 2021 (Test Report No. 20212038).

## 15. PRODUCT INFORMATION SHEET IN REFERENCE TO E.U. REGULATION 1369/2017

Product Information Sheet

Trade Mark

AEG

Model	TR88AA64C PNC916099941
Rated capacity in kg	8,0
Air vented or condenser tumble dryer	Condenser
Energy efficiency class	A+++
Energy consumption in kWh per year, based on 160 drying cycles of the standard cotton programme at full and partial load, and the consumption of the low-power modes. Actual energy consumption per cycle will depend on how the appliance is used.	176,50
Automatic tumble drier or non-automatic tumble drier	Automatic
Energy consumption of the standard cotton programme at full load in kWh	1,49
Energy consumption of the standard cotton programme at partial load in kWh	0,81
Power consumption of the off-mode in W	0,05
Power consumption in left-on mode in W	0,05
Duration of the left on mode in minutes	10
The 'standard cotton programme' used at full and partial load is the standard drying programme to which the information in the label and the fiche relates, this programme is suitable for drying normal wet cotton laundry and it is the most efficient programme in terms of energy consumption for cotton.	
Weighted programme time of the 'standard cotton programme at full and partial load' in minutes	135
Programme time of the 'standard cotton programme at full load' in minutes	175
Programme time of the 'standard cotton programme at partial load' in minutes	105
Condensation efficiency class on a scale from G (least efficient) to A (most efficient)	B
Average condensation efficiency of the standard cotton programme at full load as a percentage	86
Average condensation efficiency of the standard cotton programme at partial load as a percentage	86
Weighted condensation efficiency for the 'standard cotton programme at full and partial load'	86
Sound power level in dB	65
Built in appliance Y/N	No

The information given in the chart above is compliant with the EU Commission regulation 392/2012 implementing directive 2009/125/EC.

## 16. ENVIRONMENTAL CONCERNS

Recycle materials with the symbol . Put the packaging in relevant containers to recycle it. Help protect the environment and human health by recycling waste of electrical and

electronic appliances. Do not dispose of appliances marked with the symbol  with the household waste. Return the product to

your local recycling facility or contact your municipal office.

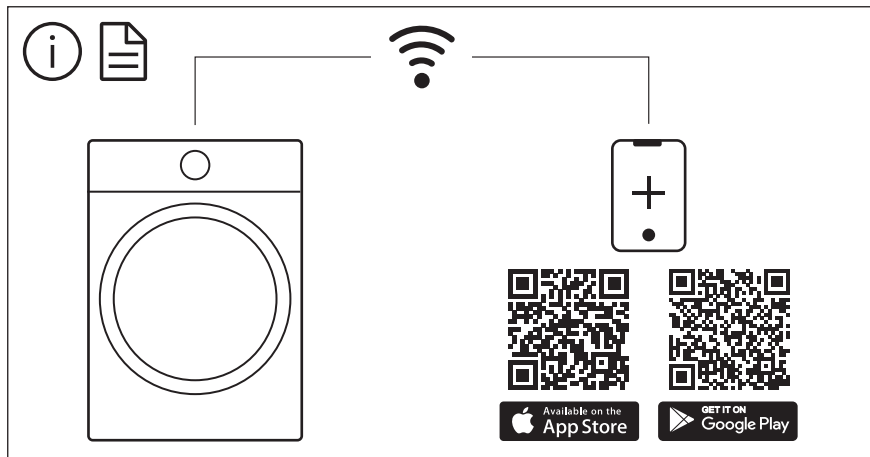

The software in this product contains components that are based on free and open source software. AEG gratefully acknowledges the contributions of the open software and robotics communities to the development project.

To access the source code of these free and open source software components whose license conditions require publishing, and to see their full copyright information and applicable license terms, please visit:  
<http://aeg.opensoftwarerepository.com> (folder NIUS)